

Quick Reference

Using the 2.4-inch display printer model

Learning about the printer

Using the printer control panel

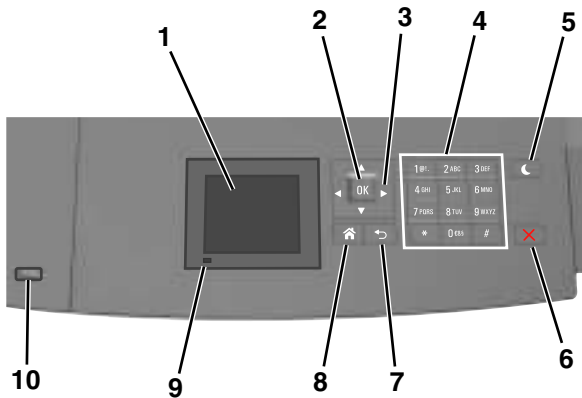

	Use the	To
1	Display	<ul style="list-style-type: none"> View the printer status. Set up and operate the printer.
2	Select button	Submit changes made in the printer settings.
3	Arrow buttons	Scroll up and down or left and right.
4	Keypad	Enter numbers, letters, or symbols.

	Use the	To
5	Sleep button	Enable Sleep mode or Hibernate mode. Do the following to wake the printer from Sleep mode: <ul style="list-style-type: none"> Press any hard button. Pull out Tray 1 or load paper in the multipurpose feeder. Open a door or cover. Send a print job from the computer. Perform a power-on reset with the main power switch. Attach a device to the USB port on the printer.
6	Stop or Cancel button	Stop all printer activity.
7	Back button	Return to the previous screen.
8	Home button	Go to the home screen.
9	Indicator light	Check the status of the printer.
10	USB port	Connect a flash drive to the printer. Note: Only the front USB port supports flash drives.

Setting the paper size and type

- From the printer control panel, navigate to:

> Settings > > Paper Menu > > Paper Size/Type >

- Press the up or down arrow button to select the tray or feeder, and

then press .

- Press the up or down arrow button to select the paper size, and

then press .

- Press the up or down arrow button to select the paper type, and

then press to change the settings.

Configuring Universal paper settings

The Universal paper size is a user-defined setting that lets you print on paper sizes that are not preset in the printer menus.

Notes:

- The smallest supported Universal size is 70 x 127 mm (2.76 x 5 inches) for one-sided printing and 105 x 148 mm (4.13 x 5.83 inches) for two-sided (duplex) printing.
- The largest supported Universal size is 216 x 356 mm (8.5 x 14 inches) for one-sided and two-sided printing.
- When printing on paper less than 210 mm (8.3 inches) wide, the printer may print at a reduced speed after a period of time to ensure the best print performance.

From the printer control panel, navigate to:

> Settings > > Paper Menu > > Universal Setup > > Units of Measure > > select unit of measure >

Adjusting toner darkness

Using the Embedded Web Server

- Open a Web browser, and then type the IP address of the printer in the address field.

Notes:

- View the printer IP address in the TCP/IP section in the Network/Ports menu. The IP address appears as four sets of numbers separated by periods, such as 123.123.123.123.
- If you are using a proxy server, then temporarily disable it to load the Web page correctly.

- Click Settings > Print Settings > Quality Menu > Toner Darkness.

- Adjust the toner darkness, and then click Submit.

Using the printer control panel

- From the printer control panel, navigate to:

> Settings > > Print Settings > > Quality Menu > > Toner Darkness

2 Adjust the toner darkness, and then press **OK**.

Supported flash drives and file types

Notes:

- High-speed USB flash drives must support the full-speed standard. Low-speed USB devices are not supported.
- USB flash drives must support the File Allocation Table (FAT) system. Devices formatted with New Technology File System (NTFS) or any other file system are not supported.

Recommended flash drives	File type
Many flash drives are tested and approved for use with the printer. For more information, contact the place where you purchased the printer.	Documents: <ul style="list-style-type: none">• .pdf• .xps Images: <ul style="list-style-type: none">• .dcm• .gif• .jpeg or .jpg• .bmp• .pcx• .tiff or .tif• .png• .fls

Printing from a flash drive

Notes:

- Before printing an encrypted PDF file, you will be prompted to enter the file password from the printer control panel.
- You cannot print files for which you do not have printing permissions.

1 Insert a flash drive into the USB port.

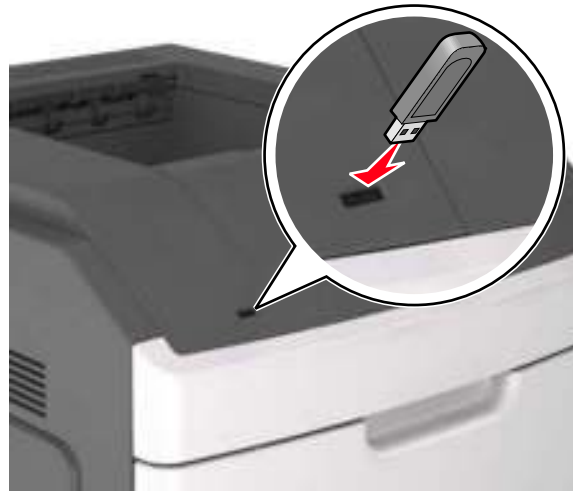

Notes:

- A flash drive icon appears on the printer control panel and in the held jobs icon when a flash drive is installed.
- If you insert the flash drive when the printer requires attention, such as when a jam has occurred, then the printer ignores the flash drive.
- If you insert the flash drive while the printer is processing other print jobs, then **Busy** appears. After these print jobs are processed, you may need to view the held jobs list to print documents from the flash drive.

Warning—Potential Damage: Do not touch the printer or the flash drive in the area shown while actively printing, reading, or writing from the memory device. Loss of data can occur.



2 From the printer control panel, select the document you want to print.

3 Press the left or right arrow button to specify the number of copies

for printing, and then press **OK**.

Notes:

- Do not remove the flash drive from the USB port until the document has finished printing.
- If you leave the flash drive in the printer after leaving the initial USB menu screen, then access held jobs from the printer control panel to print files from the flash drive.

Canceling a print job from the printer control panel

From the printer control panel, press **X** > **OK**.

Linking and unlinking trays

1 Open a Web browser, and then type the printer IP address in the address field.

Notes:

- View the printer IP address on the printer control panel in the TCP/IP section under the Network/Ports menu. The IP address appears as four sets of numbers separated by periods, such as 123.123.123.123.

- If you are using a proxy server, then temporarily disable it to load the Web page correctly.

2 Click **Settings > Paper Menu**.

3 Change the paper size and type settings for the trays you are linking.

- To link trays, make sure the paper size and type for the tray match that of the other tray.
- To unlink trays, make sure the paper size or type for the tray does *not* match that of the other tray.

4 Click **Submit**.

Note: You can also change the paper size and type settings using the printer control panel. For more information, see “Setting the paper size and type” on page 1.

Warning—Potential Damage: Paper loaded in the tray should match the paper type name assigned in the printer. The temperature of the fuser varies according to the specified paper type. Printing issues may occur if settings are not properly configured.

Using the 4.3-inch touch-screen printer model

Learning about the printer

Using the printer control panel

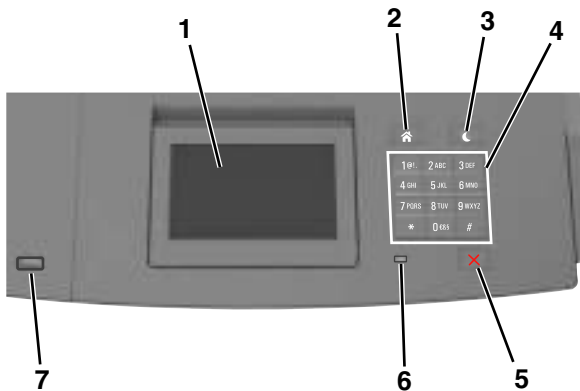

	Use the	To
1	Display	<ul style="list-style-type: none"> • View the printer status. • Set up and operate the printer.
2	Home button	Go to the home screen.
3	Sleep button	Enable Sleep mode or Hibernate mode. Do the following to wake the printer from Sleep Mode: <ul style="list-style-type: none"> • Press any hard button. • Pull out Tray 1 or load paper in the multipurpose feeder. • Open a door or cover. • Send a print job from the computer. • Perform a power-on reset with the main power switch. • Attach a device to the USB port on the printer.
4	Keypad	Enter numbers, letters, or symbols.
5	Stop or Cancel button	Stop all printer activity.
6	Indicator light	Check the status of the printer.
7	USB port	Connect a flash drive to the printer. Note: Only the front USB port supports flash drives.

Understanding the home screen

When the printer is turned on, the display shows a basic screen, referred to as the home screen. Use the home screen buttons and icons to initiate an action.

Note: Your home screen may vary depending on your home screen customization settings, administrative setup, and active embedded solutions.

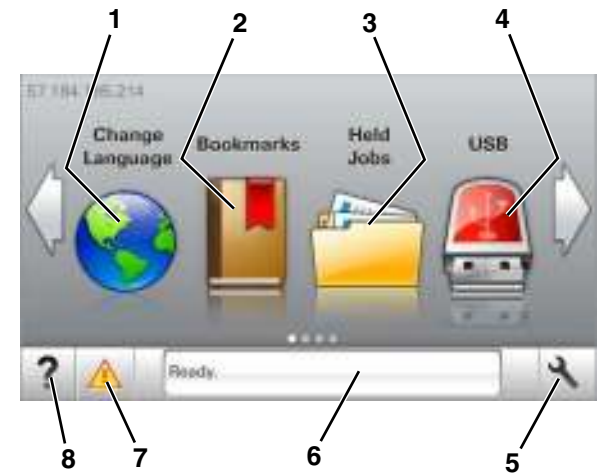



Touch	To	To
1	Change Language	Change the primary language of the printer.
2	Bookmarks	Create, organize, and save a set of bookmarks (URLs) into a tree view of folders and file links. Note: The tree view does not include bookmarks created within Forms and Favorites, and the ones in the tree are not usable in Forms and Favorites.
3	Held Jobs	Display all current held jobs.
4	USB	View, select, or print photos and documents from a flash drive. Note: This icon appears only when you return to the home screen while a memory card or flash drive is connected to the printer.
5	Menus	Access printer menus. Note: These menus are available only when the printer is in ready state.
6	Status message bar	<ul style="list-style-type: none"> • Show the current printer status such as Ready or Busy. • Show printer conditions such as Imaging unit low or Cartridge Low. • Show intervention messages and the instructions on how to clear them.

Touch	To
7	Status/Supplies <ul style="list-style-type: none"> Show a printer warning or error message whenever the printer requires intervention to continue processing. View more information on the printer warning or message, and on how to clear it.
8	Tips <p>View a context-sensitive help information.</p>

This may also appear on the home screen:

Touch	To
Search Held Jobs	Search current held jobs.
Jobs by user	Access print jobs saved by user.
Profiles and Solutions	Access profiles and solutions.

Features

Feature	Description
Attendance message alert 	If an attendance message affects a function, then this icon appears and the red indicator light blinks.
Warning 	If an error condition occurs, then this icon appears.
Printer IP address Example: 123 . 123 . 123 . 123	The IP address of your printer is located at the top left corner of the home screen and appears as four sets of numbers separated by periods. You can use the IP address when accessing the Embedded Web Server to view and remotely configure printer settings even when you are not physically near the printer.

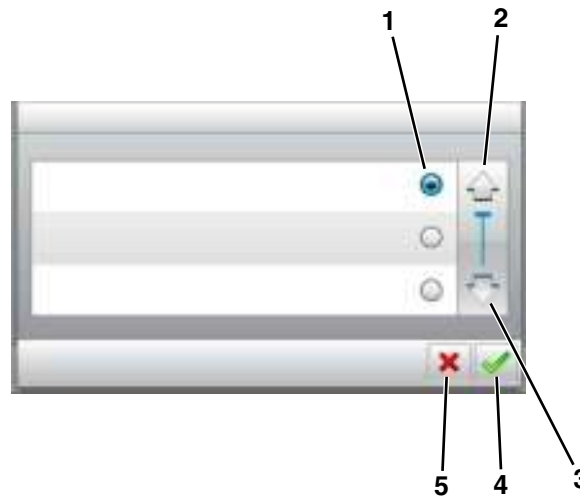

Using the touch-screen buttons

Note: Your home screen may vary, depending on your home screen customization settings, administrative setup, and active embedded solutions.



	Touch the	To
1	Radio button	Select or clear an item.
2	Up arrow	Scroll up.
3	Down arrow	Scroll down.
4	Accept button	Save a setting.
5	Cancel button	<ul style="list-style-type: none"> Cancel an action or a selection. Return to the previous screen.



Other touch-screen buttons

Touch	To
	Return to the home screen.
	Open a context-sensitive Help dialog on the printer control panel.
	Scroll to the left.

Touch	To
	Scroll to the right.

Setting the paper size and type

From the home screen navigate to:

 > Paper Menu > Paper Size/Type > select a tray > select the paper size or type > 

Configuring Universal paper settings

The Universal paper size is a user-defined setting that lets you print on paper sizes that are not preset in the printer menus.

Notes:

- The smallest supported Universal size is 70 x 127 mm (2.76 x 5 inches) for one-sided printing and 105 x 148 mm (4.13 x 5.83 inches) for two-sided (duplex) printing.
- The largest supported Universal size is 216 x 356 mm (8.5 x 14 inches) for one-sided and two-sided printing.
- When printing on paper less than 210 mm (8.3 inches) wide, the printer may print at a reduced speed after a period of time to ensure the best print performance.

1 From the home screen, navigate to:

 > Paper Menu > Universal Setup > Units of Measure > select a unit of measure

2 Touch **Portrait Width** or **Portrait Height**.

3 Select the width or height, and then touch .

Adjusting toner darkness

Using the Embedded Web Server

1 Open a Web browser, and then type the printer IP address in the address field.

Notes:

- View the printer IP address on the printer home screen. The IP address appears as four sets of numbers separated by periods, such as 123.123.123.123.
- If you are using a proxy server, then temporarily disable it to load the Web page correctly.

2 Click **Settings > Print Settings > Quality Menu > Toner Darkness**.

3 Adjust the setting, and then click **Submit**.

Using the printer control panel

1 From the home screen, navigate to:



> **Settings > Print Settings > Quality Menu > Toner Darkness**

2 Adjust the setting, and then touch .

Supported flash drives and file types

Notes:

- High-speed USB flash drives must support the full-speed standard. Low-speed USB devices are not supported.
- USB flash drives must support the File Allocation Table (FAT) system. Devices formatted with New Technology File System (NTFS) or any other file system are not supported.

Recommended flash drives	File type
Many flash drives are tested and approved for use with the printer. For more information, contact the place where you purchased the printer.	Documents: <ul style="list-style-type: none">• .pdf• .xps Images: <ul style="list-style-type: none">• .dcm• .gif• .jpeg or .jpg• .bmp• .pcx• .tiff or .tif• .png• .fls

Printing from a flash drive

Notes:

- Before printing an encrypted PDF file, you will be prompted to type the file password from the printer control panel.
- You cannot print files for which you do not have printing permissions.

1 Insert a flash drive into the USB port.

Notes:

- A flash drive icon appears on the printer home screen when a flash drive is inserted.
- If you insert the flash drive when the printer requires attention, such as when a jam has occurred, then the printer ignores the flash drive.
- If you insert the flash drive while the printer is processing other print jobs, then **Busy** appears. After these print jobs are processed, you may need to view the held jobs list to print documents from the flash drive.

Warning—Potential Damage: Do not touch the printer or the flash drive in the area shown while actively printing, reading, or writing from the memory device. Loss of data can occur.



2 From the printer control panel, touch the document you want to print.

3 Touch the arrows to specify the number of copies for printing, and then touch **Print**.

Notes:

- Do not remove the flash drive from the USB port until the document has finished printing.
- If you leave the flash drive in the printer after leaving the initial USB menu screen, then touch **Held Jobs** on the home screen to print files from the flash drive.

Canceling a print job from the printer control panel

- 1 From the printer control panel, touch **Cancel Jobs** or press  on the keypad.
- 2 Touch the print job you want to cancel, and then touch **Delete Selected Jobs**.

Linking and unlinking trays

- 1 Open a Web browser, and then type the printer IP address in the address field.

Notes:

- View the printer IP address on the printer home screen. The IP address appears as four sets of numbers separated by periods, such as 123.123.123.123.
- If you are using a proxy server, then temporarily disable it to load the Web page correctly.

2 Click **Settings > Paper Menu**.

3 Change the paper size and type settings for the trays you are linking.

- To link trays, make sure the paper size and type for the tray match that of the other tray.
- To unlink trays, make sure the paper size or type for the tray does *not* match that of the other tray.

4 Click **Submit**.

Note: You can also change the paper size and type settings using the printer control panel. For more information, see “Setting the paper size and type” on page 4.

Warning—Potential Damage: Paper loaded in the tray should match the paper type name assigned in the printer. The temperature of the fuser varies according to the specified paper type. Printing issues may occur if settings are not properly configured.

Using the 7-inch touch-screen printer model

Learning about the printer

Using the printer control panel

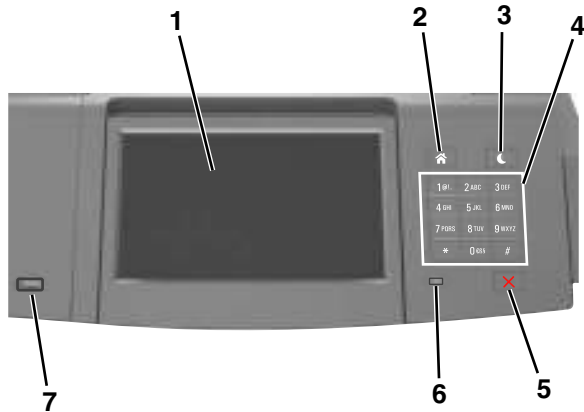

	Use the	To
1	Display	<ul style="list-style-type: none"> View the status of the printer. Set up and operate the printer.
2	Home button	Go to the home screen.
3	Sleep button	Enable Sleep mode or Hibernate mode. Do the following to wake the printer from Sleep mode: <ul style="list-style-type: none"> Press and release the Sleep button. Touch the screen or press any hard button. Open a tray, cover, or door. Send a print job from the computer. Perform a power-on reset with the main power switch. Attach a device to a USB port.
4	Keypad	Enter numbers, letters, or symbols on the printer.

	Use the	To
5	Stop or Cancel button	Stop all printer activity.
6	Indicator light	Check the status of the printer.
7	USB port	Connect a USB Bluetooth adapter or a flash drive to the printer. Note: Only the front USB port supports flash drives.

Understanding the home screen

When the printer is turned on, the display shows a basic screen, referred to as the home screen. Use the home screen buttons and icons to initiate an action.

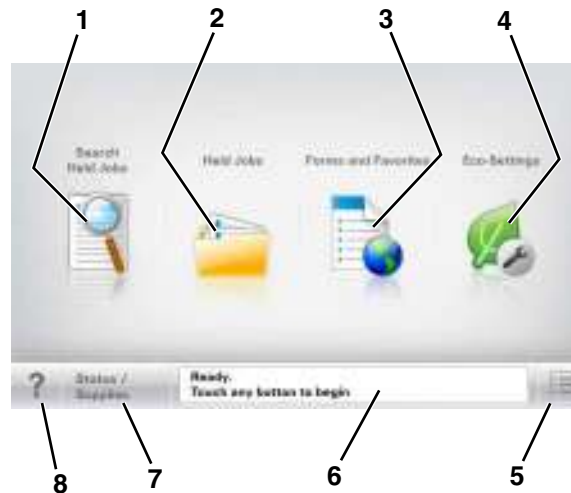

Note: Your home screen may vary depending on your home screen customization settings, administrative setup, and active embedded solutions.



	Touch	To
1	Search Held Jobs	Search current held jobs.
2	Held Jobs	Display all current held jobs.
3	Forms and Favorites	Access frequently used online forms.

	Touch	To
4	Eco-Settings	Adjust energy consumption, noise, toner and paper usage.
5	Menus	Access printer menus. Note: These menus are available only when the printer is in Ready state.
6	Status message bar	<ul style="list-style-type: none"> Show the current printer status such as Ready or Busy. Show printer conditions such as Imaging unit low or Cartridge Low. Show intervention messages and the instructions on how to clear them.
7	Status/Supplies	<ul style="list-style-type: none"> Show a printer warning or error message whenever the printer requires intervention to continue processing. View more information on the printer warning or message, and on how to clear it.
8	Tips	Open a context-sensitive Help information on the printer control panel.



Features



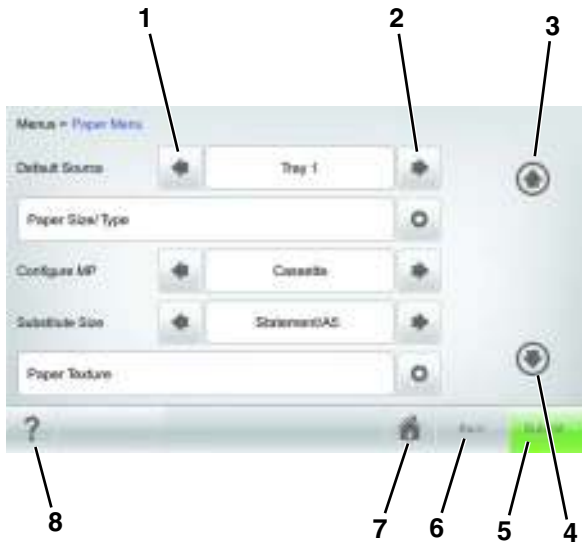

Feature	Description
Attendance message alert 	If an attendance message affects a function, then this icon appears and the red indicator light blinks.
Warning 	If an error condition occurs, then this icon appears.
Printer IP address Example: 123 . 123 . 123 . 123	The IP address of your network printer is located at the top left corner of the home screen and appears as four sets of numbers separated by periods. You can use the IP address when accessing the Embedded Web Server so you can view and remotely configure printer settings even when you are not physically near the printer.

Using the touch-screen buttons



Note: Your home screen, icons, and buttons may vary, depending on your home screen customization settings, administrative setup, and active embedded solutions.





	Touch	To
1	Left arrow 	Scroll to the left.
2	Right arrow 	Scroll to the right.
3	Up arrow 	Scroll up.

	Touch	To
4	Down arrow 	Scroll down.
5	Submit 	Submit changes made in the printer settings.
6	Back 	Return to the previous screen.
7	Home 	Return to the home screen.
8	Tips 	Open a context-sensitive Help dialog on the printer control panel.

Other touch-screen buttons

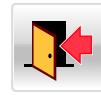
	Touch	To
	Accept 	Save settings.
	Cancel 	<ul style="list-style-type: none"> Cancel an action or a selection. Leave a screen and return to the previous screen without saving changes.
	Increase 	Select a higher value.

	Touch	To
	Decrease 	Select a lower value.
	Exit 	Leave the current screen.
	Search 	Search current held jobs.
	Warning 	View a warning or error message.

Setting the paper size and type

From the home screen navigate to:

 > **Paper Menu** > **Paper Size/Type** > select a tray > select a paper size or type > **Submit**

Notes:

- The paper size is automatically set according to the position of the paper guides in each tray except the multipurpose feeder.
- The paper size for the multipurpose feeder must be set manually from the Paper Size menu.
- The paper type must be set manually for all trays that do not contain plain paper.

Configuring Universal paper settings

Universal paper size is a user-defined setting that lets you print on paper sizes that are not preset in the printer menus.

Notes:

- The smallest supported Universal size is 70 x 127 mm (2.76 x 5 inches) for one-sided printing and 105 x 148 mm (4.13 x 5.83 inches) for two-sided (duplex) printing.
- The largest supported Universal size is 216 x 356 mm (8.5 x 14 inches) for one-sided and two-sided printing.
- When printing on paper less than 210 mm (8.3 inches) wide, the printer may print at a reduced speed after a period of time to ensure the best print performance.

1 From the home screen, navigate to:



> **Paper Menu** > **Universal Setup** > **Units of Measure** > select a unit of measure

2 Touch **Portrait Width** or **Portrait Height**.

3 Select the width or height, and then touch **Submit**.

Adjusting toner darkness

1 Open a Web browser, and then type the printer IP address in the address field.

Notes:

- View the printer IP address on the printer home screen. The IP address appears as four sets of numbers separated by periods, such as 123.123.123.123.
- If you are using a proxy server, then temporarily disable it to load the Web page correctly.

2 Click **Settings** > **Print Settings** > **Quality Menu** > **Toner Darkness**.

3 Adjust the toner darkness, and then click **Submit**.

Using the printer control panel

1 From the home screen, navigate to:



> **Settings** > **Print Settings** > **Quality Menu** > **Toner Darkness**

2 Adjust the setting, and then touch **Submit**.

Supported flash drives and file types

Notes:

- High-speed USB flash drives must support the full-speed standard. Low-speed USB devices are not supported.

- USB flash drives must support the File Allocation Table (FAT) system. Devices formatted with New Technology File System (NTFS) or any other file system are not supported.

Recommended flash drives	File type
Many flash drives are tested and approved for use with the printer. For more information, contact the place where you purchased the printer.	Documents: <ul style="list-style-type: none">• .pdf• .xps Images: <ul style="list-style-type: none">• .dcm• .gif• .jpeg or .jpg• .bmp• .pcx• .tiff or .tif• .png• .fls

Printing from a flash drive

Notes:

- Before printing an encrypted PDF file, you will be prompted to type the file password from the printer control panel.
- You cannot print files for which you do not have printing permissions.

1 Insert a flash drive into the USB port.

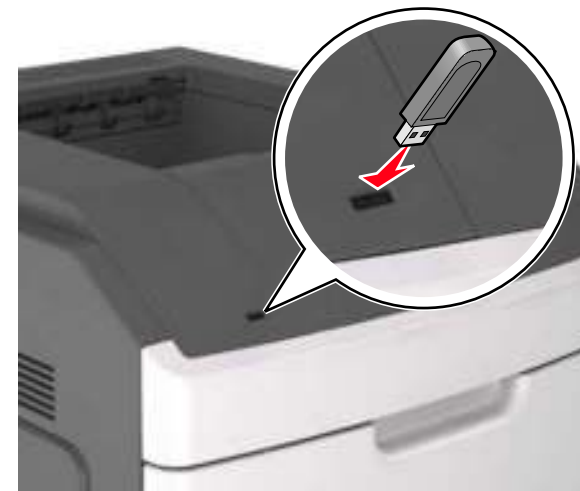

Notes:

- A flash drive icon appears on the printer home screen when a flash drive is inserted.
- If you insert the flash drive when the printer requires attention, such as when a jam has occurred, then the printer ignores the flash drive.
- If you insert the flash drive while the printer is processing other print jobs, then **Busy** appears. After these print jobs are processed, you may need to view the held jobs list to print documents from the flash drive.

Warning—Potential Damage: Do not touch the USB cable, any wireless network adapter, any connector, the memory device, or the printer in the areas shown while actively printing, reading, or writing from the memory device. Loss of data can occur.



- 2 From the printer control panel, touch the document you want to print.
- 3 Touch the arrows to specify the number of copies for printing, and then touch **Print**.

Notes:

- Do not remove the flash drive from the USB port until the document has finished printing.
- If you leave the flash drive in the printer after leaving the initial USB menu screen, then touch **Held Jobs** on the home screen to print files from the flash drive.

Canceling a print job from the printer control panel

- 1 Touch **Cancel Jobs** on the printer control panel, or press  on the keypad.
- 2 Touch the print job you want to cancel, and then touch **Delete Selected Jobs**.

Linking and unlinking trays

- 1 Open a Web browser, and then type the printer IP address in the address field.

Notes:

- View the printer IP address on the printer home screen. The IP address appears as four sets of numbers separated by periods, such as 123.123.123.123.
- If you are using a proxy server, then temporarily disable it to load the Web page correctly.

2 Click **Settings > Paper Menu**.

3 Change the paper size and type settings for the trays you are linking.

- To link trays, make sure the paper size and type for the tray match that of the other tray.
- To unlink trays, make sure the paper size or type for the tray *does not* match that of the other tray.

4 Click **Submit**.

Note: You can also change the paper size and type settings using the printer control panel. For more information, see “Setting the paper size and type” on page 7.

Warning—Potential Damage: Paper loaded in the tray should match the paper type name assigned in the printer. The temperature of the fuser varies according to the specified paper type. Printing issues may occur if settings are not properly configured.

Using the 4.3- and 7-inch touch screens

Setting up and using the home screen applications

Notes:

- Your home screen, icons, and buttons may vary depending on your home screen customization settings, administrative setup, and active embedded applications. Some applications are supported only on select printer models.
- There may be additional solutions and applications available for purchase. To learn more, inquire at your point of purchase.

Finding the IP address of the printer

Note: Make sure your printer is connected to a network or to a print server.

You can find the printer IP address:

- From the top left corner of the printer home screen.
- From the TCP/IP section in the Network/Ports menu.
- By printing a network setup page or menu settings page, and then finding the TCP/IP section.

Note: An IP address appears as four sets of numbers separated by periods, such as 123.123.123.123.

Finding the IP address of the computer

Note: Make sure that you know how your printer and computer are connected to the network (Ethernet or wireless).

The computer IP address is required when setting up home screen applications, such as:

- Forms and Favorites
- Multi Send
- Scan to Network

For Windows users

- 1 Open the command window.

In Windows 8

From the Search charm, type **run**, and then navigate to:

Apps list > **Run** > type **cmd** > **OK**

In Windows 7 or earlier

- a Click  or click **Start**, and then click **Run**.
- b In the Start Search or Run dialog, type **cmd**.
- c Press **Enter**, or click **OK**.

- 2 Type **ipconfig**, and then click **Go** or press **Enter**.

Note: Type **ipconfig /all** to see additional useful information.

- 3 Look for **IP Address**.

The IP address appears as four sets of numbers separated by periods, such as 123.123.123.123.

For Macintosh users

Note: This is applicable only in Mac OS X version 10.5 or later.

- 1 From the Apple menu, navigate to:
System Preferences > Network
- 2 Click **Ethernet, Wi-Fi, or AirPort**.

- 3 Click **Advanced > TCP/IP**.
- 4 Look for **IPv4 Address**.

Accessing the Embedded Web Server

The Embedded Web Server is the printer Web page that lets you view and remotely configure printer settings even when you are not physically near the printer.

- 1 Obtain the printer IP address:
 - From the printer control panel home screen
 - From the TCP/IP section in the Network/Ports menu
 - By printing a network setup page or menu settings page, and then finding the TCP/IP section

Note: An IP address appears as four sets of numbers separated by periods, such as 123.123.123.123.

- 2 Open a Web browser, and then type the printer IP address in the address field.
- 3 Press **Enter**.

Note: If you are using a proxy server, then temporarily disable it to load the Web page correctly.

Customizing the home screen

- 1 Open a Web browser, and then type the printer IP address in the address field.

Note: View the printer IP address on the printer home screen. The IP address appears as four sets of numbers separated by periods, such as 123.123.123.123.

- 2 Do one or more of the following:
 - Show or hide icons of basic printer functions.
 - a Click **Settings > General Settings > Home screen customization**.
 - b Select the check boxes to specify which icons appear on the printer home screen.

Note: If you clear a check box beside an icon, then the icon does not appear on the home screen.
 - c Click **Submit**.
 - Customize the icon for an application. For more information, see “Finding information about the home screen applications” on page 10 or see the documentation that came with the application.

Activating the home screen applications

Your printer comes with preinstalled home screen applications. Before you can use these applications, first activate and set up these applications using the Embedded Web Server. For more information about accessing the Embedded Web Server, see “Accessing the Embedded Web Server” on page 10.

For detailed information about configuring and using the home screen applications, contact the place where you bought the printer.

Finding information about the home screen applications

Your printer comes with preinstalled home screen applications. Before you can use these applications, you must first activate and set up these applications using the Embedded Web Server. For more information on accessing the Embedded Web Server, see “Accessing the Embedded Web Server” on page 10.

For detailed information on configuring and using the home screen applications, contact the place where you purchased the printer.

Using Background and Idle Screen

Use	To
	Customize the background and idle screen of your printer home screen.

From the home screen, navigate to:

Change Background > select background to use > Apply

Setting up Forms and Favorites

Use	To
	Quickly find and print frequently used online forms directly from the printer home screen. <p>Note: The printer must have permission to access the network folder, FTP site, or Web site where the bookmark is stored. From the computer where the bookmark is stored, use sharing, security, and firewall settings to allow the printer at least a <i>read</i> access. For help, see the documentation that came with your operating system.</p>

- 1 Open a Web browser, and then type the printer IP address in the address field.

Note: View the printer IP address on the printer home screen. The IP address appears as four sets of numbers separated by periods, such as 123.123.123.123.

- 2 Click **Settings > Apps > Apps Management > Forms and Favorites**.
- 3 Click **Add**, and then customize the settings.

Notes:

- See the mouse-over help beside each field for a description of the setting.
- To make sure the location settings of the bookmark are correct, type the correct IP address of the host computer where the bookmark is located. For more information on obtaining the IP address of the host computer, see “Finding the IP address of the computer” on page 9.
- Make sure the printer has access rights to the folder where the bookmark is located.

- 4 Click **Apply**.

To use the application, touch **Forms and Favorites** on the printer home screen, and then navigate through form categories, or search for forms based on a form number, name, or description.

Setting up Remote Operator Panel

This application shows the printer control panel on your computer screen and lets you interact with the printer control panel, even when you are not physically near the network printer. From your computer screen, you can view the printer status, release held print jobs, create bookmarks, and do other print-related tasks you might normally perform on the network printer.

- 1 Open a Web browser, and then type the printer IP address in the address field.

Note: View the printer IP address on the printer home screen. The IP address appears as four sets of numbers separated by periods, such as 123.123.123.123.

- 2 Click **Settings > Remote Operator Panel Settings**.
- 3 Select the **Enabled** check box, and then customize the settings.
- 4 Click **Submit**.

To use the application, click **Remote Operator Panel > Launch VNC Applet**.

Understanding Eco-Settings

Use	To
	Manage energy consumption, noise, toner, and paper usage settings to help reduce the environmental impact of your printer.

Exporting and importing a configuration

You can export configuration settings into a text file, and then import the file to apply the settings to other printers.

- 1 Open a Web browser, and then type the printer IP address in the address field.

Note: View the printer IP address on the printer home screen. The IP address appears as four sets of numbers separated by periods, such as 123.123.123.123.

- 2 To export or import a configuration for one application, do the following:
 - a Click **Settings > Apps > Apps Management**.
 - b From the list of installed applications, click the name of the application you want to configure.
 - c Click **Configure**, and then do either of the following:
 - To export a configuration to a file, click **Export**, and then follow the instructions on the computer screen to save the configuration file.

Notes:

- When saving the configuration file, you can type a unique file name or use the default name.
- If a "JVM Out of Memory" error occurs, then repeat the export process until the configuration file is saved.
- To import a configuration from a file, click **Import**, and then browse to the saved configuration file that was exported from a previously configured printer.

Notes:

- Before importing the configuration file, you can choose to preview it first or load it directly.
- If a timeout occurs and a blank screen appears, then refresh the Web browser, and then click **Apply**.

- 3 To export or import a configuration for multiple applications, do the following:
 - a Click **Settings > Import/Export**.
 - b Do either of the following:
 - To export a configuration file, click **Export Embedded Solutions Settings File**, and then follow the instructions on the computer screen to save the configuration file.
 - To import a configuration file, do the following:
 - 1 Click **Import Embedded Solutions Settings File > Choose File**, and then browse to the saved configuration file that was exported from a previously configured printer.
 - 2 Click **Submit**.

Printing

Printing a document

- 1 From the printer control panel, set the paper type and size to match the paper loaded.
- 2 Send the print job:

For Windows users

- a With a document open, click **File > Print**.
- b Click **Properties, Preferences, Options, or Setup**.
- c Adjust the settings, if necessary.
- d Click **OK > Print**.

For Macintosh users

- a Customize the settings in the Page Setup dialog:
 - 1 With a document open, choose **File > Page Setup**.
 - 2 Choose a paper size or create a custom size to match the paper loaded.
 - 3 Click **OK**.
- b Customize the settings in the Print dialog:
 - 1 With a document open, choose **File > Print**. If necessary, click the disclosure triangle to see more options.
 - 2 From the print options pop-up menus, adjust the settings, if necessary.

Note: To print on a specific paper type, adjust the paper type setting to match the paper loaded, or select the appropriate tray or feeder.
 - 3 Click **Print**.

Canceling a print job from the computer

For Windows users

- 1 Open the printers folder.

In Windows 8

From the Search charm, type **Run**, and then navigate to:
Apps list > **Run** > type **control printers** > **OK**

In Windows 7 or earlier

- a Click , or click **Start** and then click **Run**.
 - b In the Start Search or Run dialog, type **control printers**.
 - c Press **Enter**, or click **OK**.
- 2 Double-click the printer icon.
 - 3 Select the print job you want to cancel.
 - 4 Click **Delete**.

For Macintosh users

- 1 From the Apple menu, navigate to either of the following:
 - **System Preferences > Print & Scan** > select your printer > **Open Print Queue**
 - **System Preferences > Print & Fax** > select your printer > **Open Print Queue**

- 2 From the printer window, select the print job you want to cancel, and then delete it.

Loading paper and specialty media

Loading paper and specialty media

Loading the 250- or 550-sheet tray

⚠ CAUTION—POTENTIAL INJURY: To reduce the risk of equipment instability, load each tray separately. Keep all other trays closed until needed.

- 1 Pull out the tray.

Notes:

- When loading folio-, legal-, or Oficio-size paper, lift the tray slightly and then pull it out completely.
- Do not remove trays while a job prints or while **Busy** appears on the display. Doing so may cause a jam.



- 2 Squeeze and slide the width guide to the correct position for the size of the paper being loaded until it *clicks* into place.

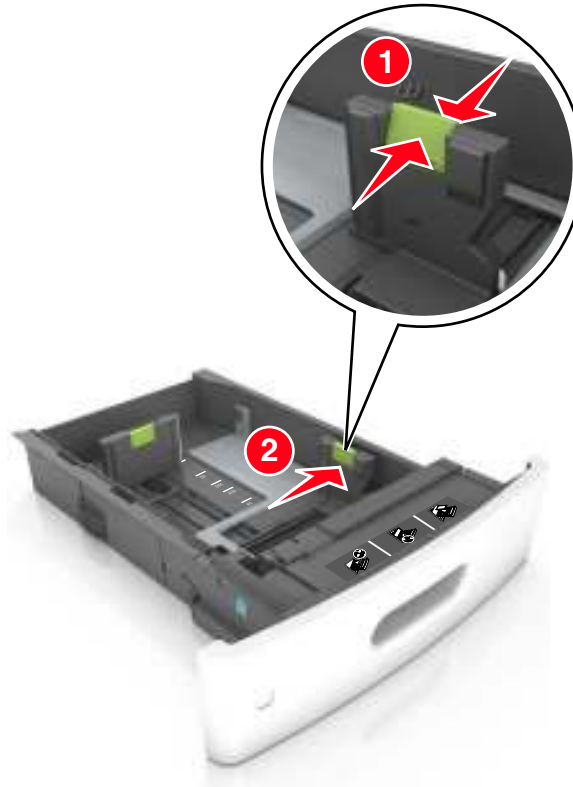

Note: Use the paper size indicators at the bottom of the tray to help position the guides.



3 Unlock the length guide, and then squeeze and slide the guide to the correct position for the size of the paper being loaded.

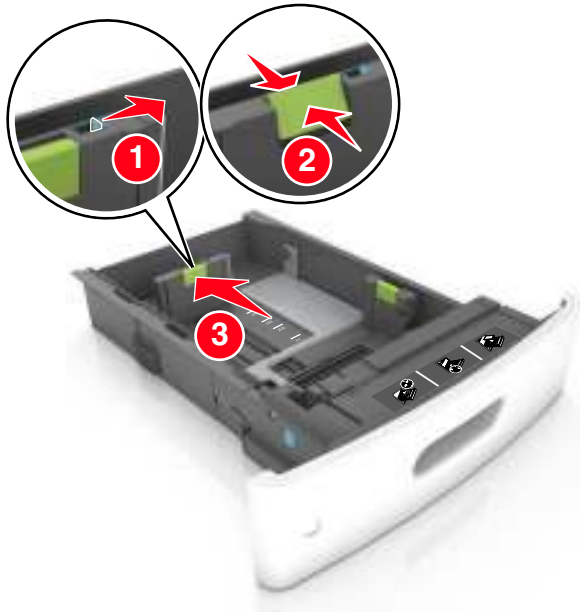

Notes:

- Lock the length guide for all paper sizes.
- Use the paper size indicators at the bottom of the tray to help position the guides.

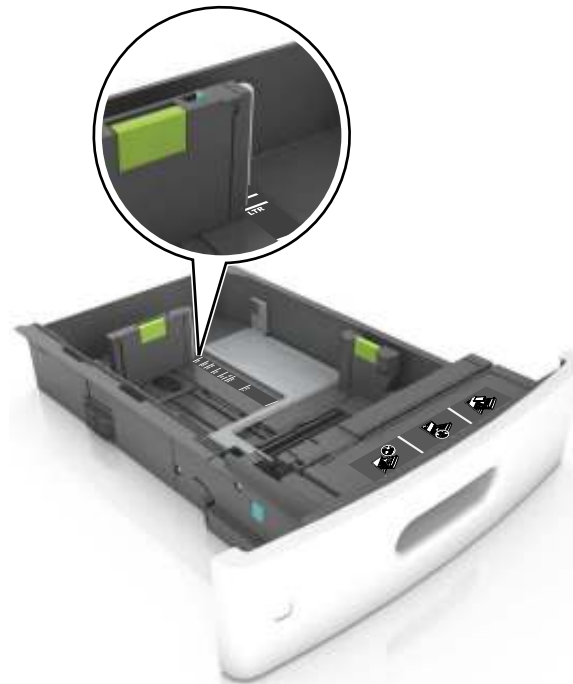

4 Flex the sheets back and forth to loosen them, and then fan them. Do not fold or crease the paper. Straighten the edges on a level surface.

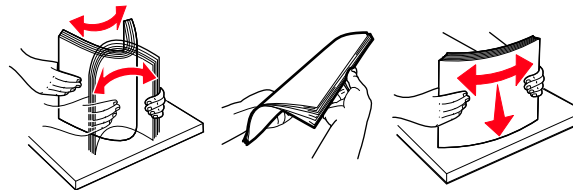

5 Load the paper stack with the printable side facedown.

Note: Make sure the paper or envelope is loaded properly.

- There are different ways of loading letterhead depending on whether an optional staple finisher is installed or not.

Without an optional staple finisher	With an optional staple finisher
<p>One-sided printing</p>	<p>One-sided printing</p>
<p>Two-sided printing</p>	<p>Two-sided printing</p>

- If you are loading prepunched paper for use with the staple finisher, then make sure the holes on the long edge of the paper are on the right side of the tray.

One-sided printing	Two-sided printing

Note: If the holes on the long edge of the paper are on the left side of the tray, then a jam may occur.

- Do not slide the paper into the tray. Load paper as shown in the illustration.

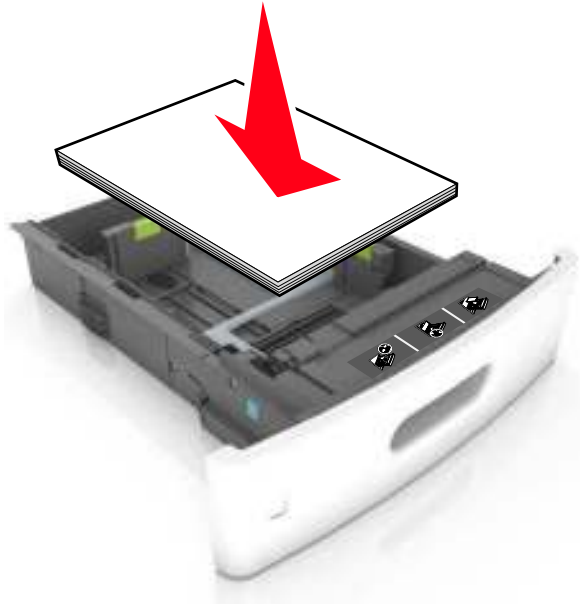

- If you are loading envelopes, then make sure that the flap side is facing up and the envelopes are on the left side of the tray.

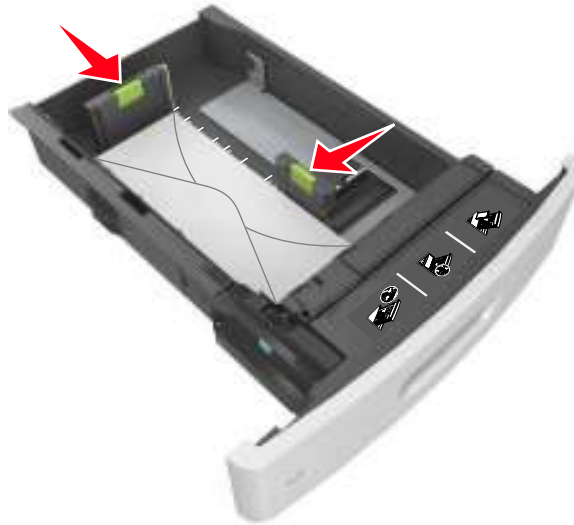

- Make sure the paper is below the solid line, which is the maximum paper fill indicator.



Warning—Potential Damage: Overfilling the tray can cause paper jams.

- When using card stock, labels, or other types of specialty media, make sure the paper is below the dashed line, which is the alternate paper fill indicator.

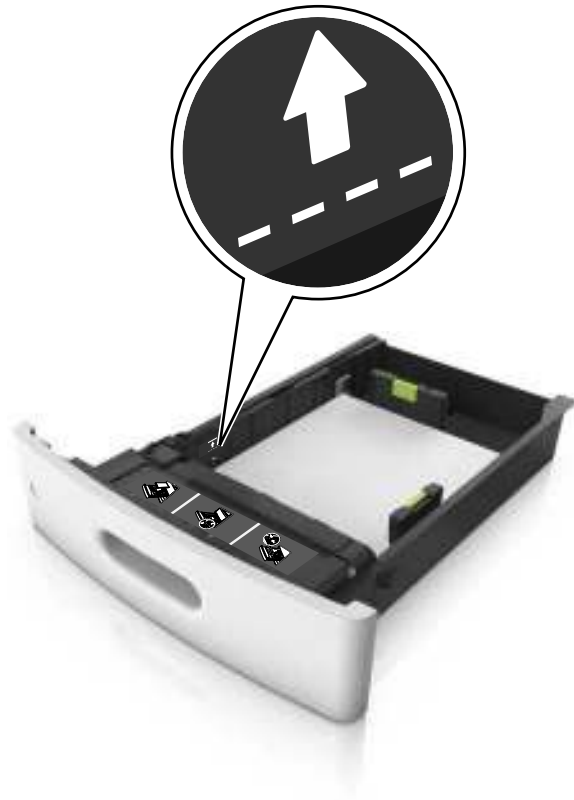

- 6 For custom- or Universal-size paper, adjust the paper guides to lightly touch the sides of the stack, and then lock the length guide.

- 7 Insert the tray.



- 8 From the printer control panel, set the paper size and paper type in the Paper menu to match the paper loaded in the tray.

Note: Set the correct paper size and type to avoid paper jams and print quality problems.

Loading the 2100-sheet tray

CAUTION—POTENTIAL INJURY: To reduce the risk of equipment instability, load each tray separately. Keep all other trays closed until needed.

- 1 Pull out the tray.
- 2 Adjust the width and length guides.

Loading A5-size paper

- a Pull up and slide the width guide to the position for A5.

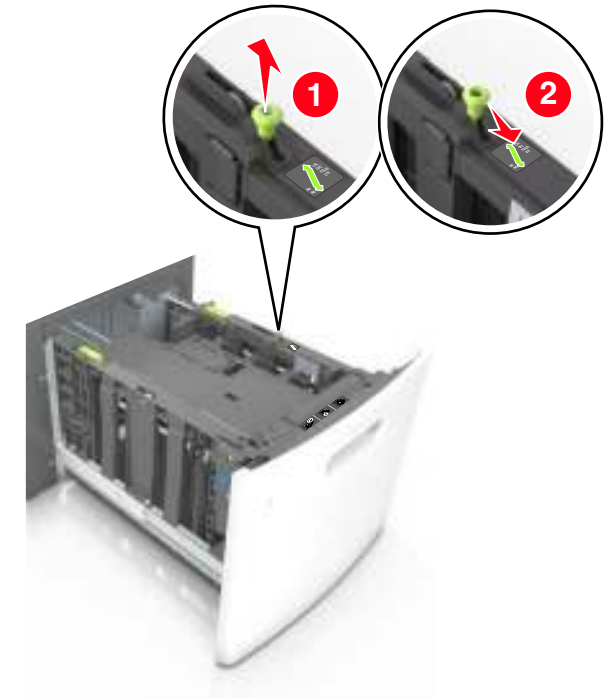

b Squeeze and slide the length guide to the position for A5 until it *clicks* into place.

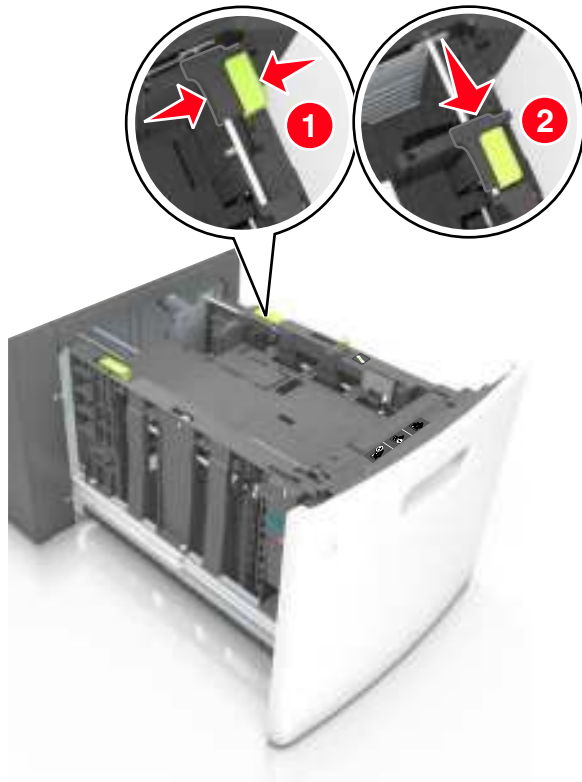

c Remove the A5 length guide from its holder.

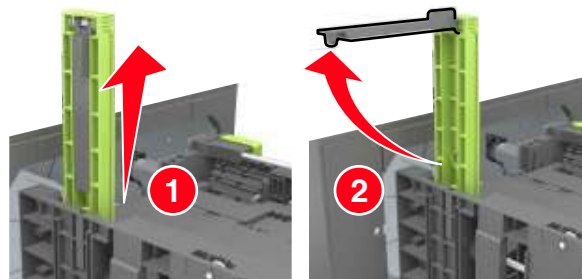

d Insert the A5 length guide into its designated slot.

Note: Press the A5 length guide until it *clicks* into place.

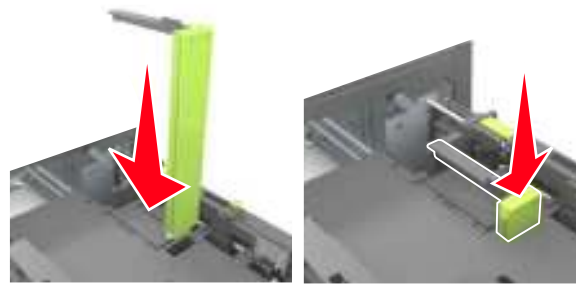

Loading A4-, letter-, legal-, oficio-, and folio-size paper

a Pull up and slide the width guide to the correct position for the size of the paper being loaded.

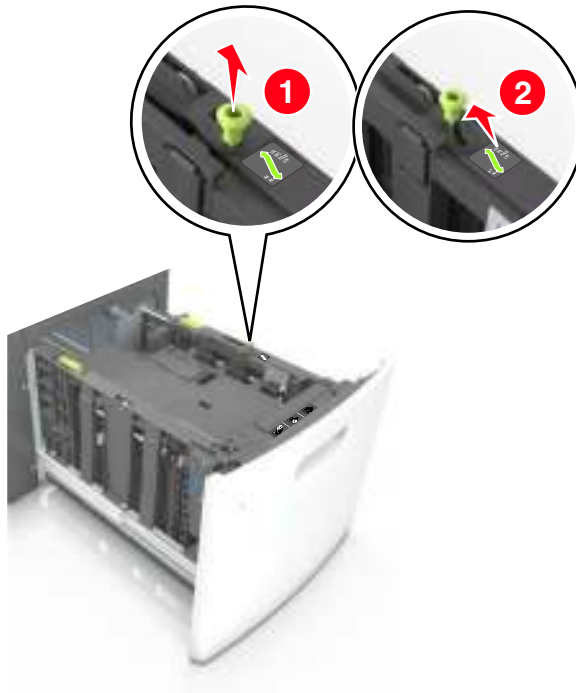

b If the A5 length guide is still attached to the length guide, then remove it from its place. If the A5 length guide is not attached, then proceed to step d.

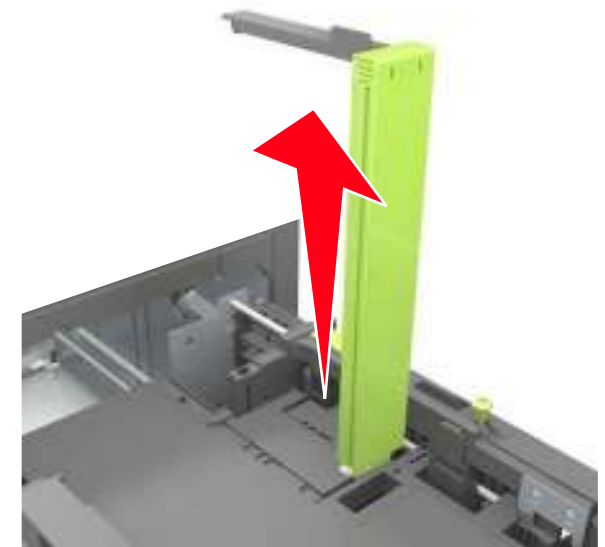

c Put the A5 length guide in its holder.

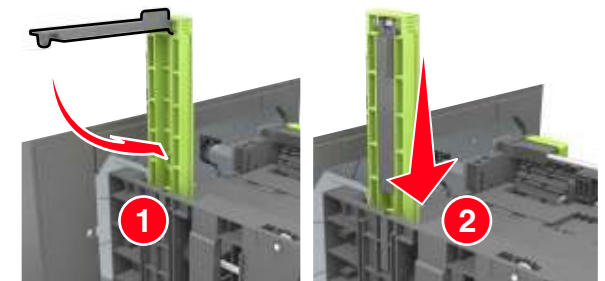

- d Squeeze the length guide and slide it to the correct position for the size of the paper being loaded until it *clicks* into place.

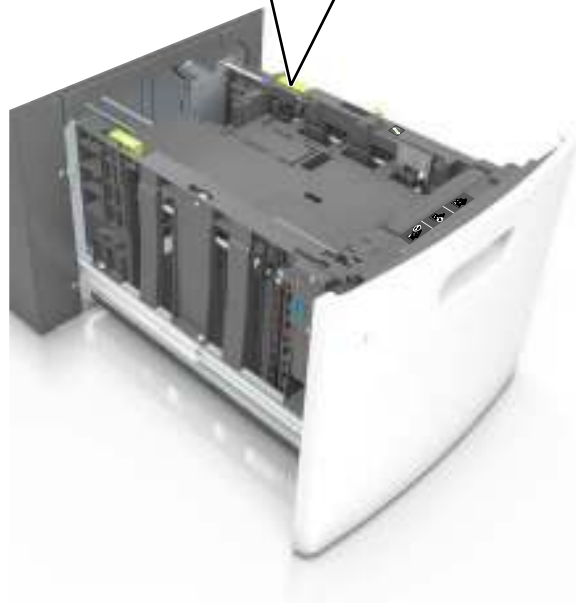
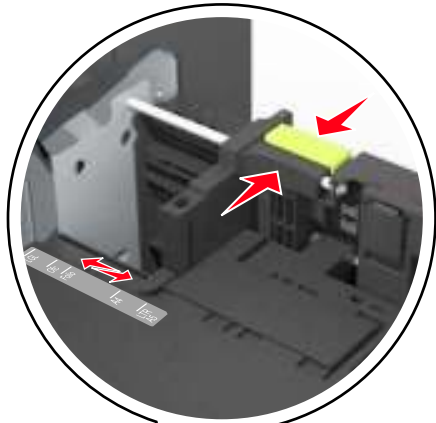



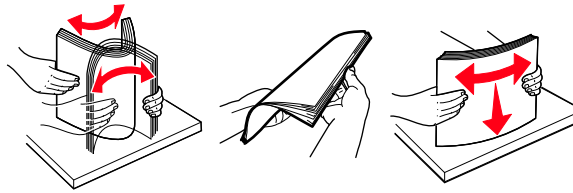

- 3 Flex sheets of paper back and forth to loosen them, and then fan them. Do not fold or crease the paper. Straighten the edges on a level surface.



- 4 Load the paper stack with the printable side facedown.

Note: Make sure the paper is loaded properly.

- There are different ways of loading letterhead depending on whether an optional staple finisher is installed or not.

Without an optional staple finisher	With an optional staple finisher
 <p>One-sided printing</p>	 <p>One-sided printing</p>
 <p>Two-sided printing</p>	 <p>Two-sided printing</p>

- If you are loading prepunched paper for use with the staple finisher, then make sure the holes on the long edge of the paper are on the right side of the tray.

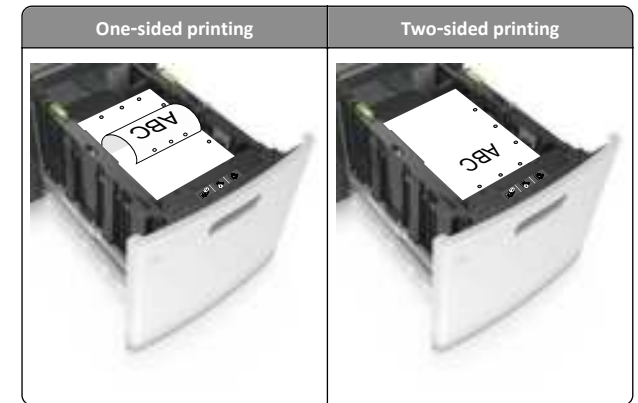

Note: If the holes on the long edge of the paper are on the left side of the tray, then a jam may occur.

- Make sure the paper is below the maximum paper fill indicator.

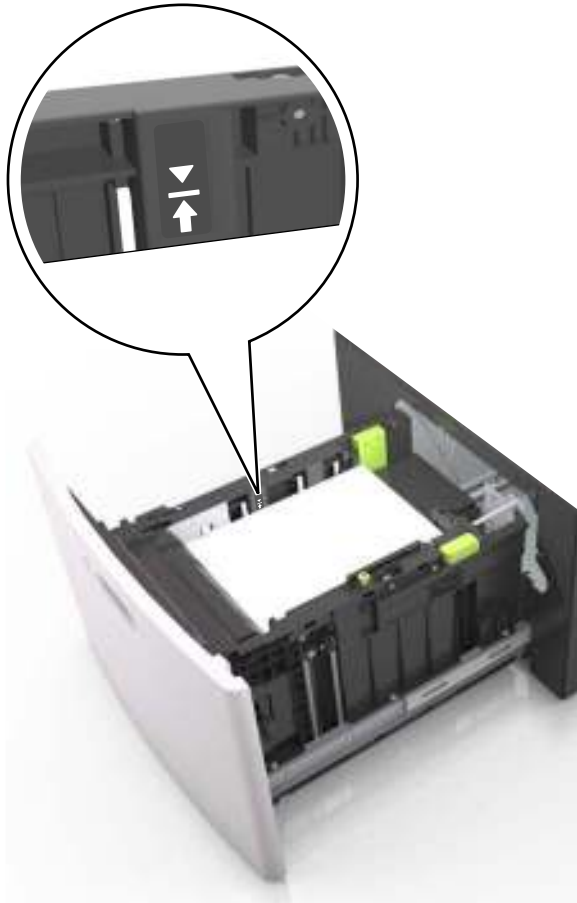

Warning—Potential Damage: Overfilling the tray can cause paper jams.

- 5 Insert the tray.

Note: Press the paper stack down while inserting the tray.

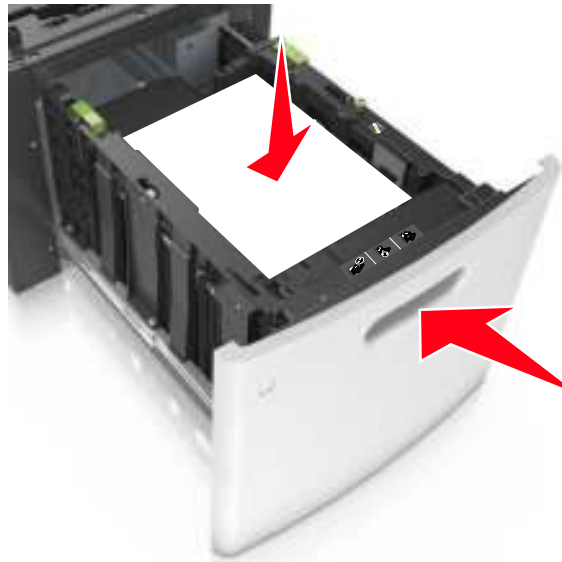

- 6 From the printer control panel, set the paper size and type in the Paper menu to match the paper loaded.

Note: Set the correct paper size and type to avoid paper jams and print quality problems.

Loading the multipurpose feeder

- 1 Pull down the multipurpose feeder door.

Note: Do not load or close the multipurpose feeder while a job is printing.



- 2 Using the handle, pull the multipurpose feeder extender.



Note: Guide the extender gently so that the multipurpose feeder is fully extended and open.

- 3 Slide the width guide to the correct position for the size of the paper being loaded.



Note: Use the paper size indicators on the bottom of tray to help position the guides.



- 4 Prepare the paper or specialty media for loading.

- Flex sheets of paper back and forth to loosen them, and then fan them. Do not fold or crease the paper. Straighten the edges on a level surface.

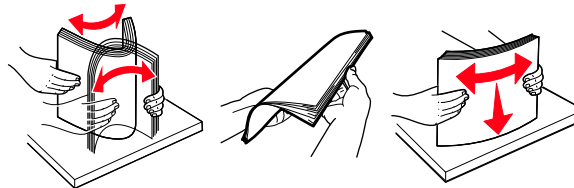

- Hold transparencies by the edges, and then fan them. Straighten the edges on a level surface.

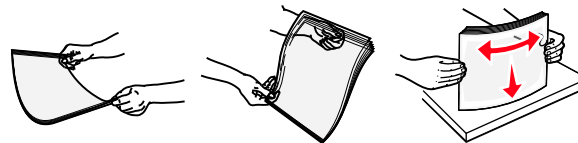

Note: Avoid touching the printable side of the transparencies. Be careful not to scratch them.

- Flex the stack of envelopes back and forth to loosen them, and then fan them. Straighten the edges on a level surface.

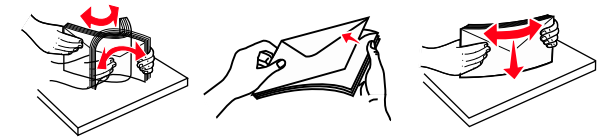

- 5 Load the paper or specialty media.

Note: Slide the stack gently into the multipurpose feeder until it comes to a stop.

- Load only one size and type of paper or specialty media at a time.
- Make sure the paper fits loosely in the multipurpose feeder, lies flat and is not bent or wrinkled.
- There are different ways of loading letterhead depending on whether an optional staple finisher is installed or not.

Without an optional staple finisher	With an optional staple finisher
<p>One-sided printing</p>	<p>One-sided printing</p>
<p>Two-sided printing</p>	<p>Two-sided printing</p>

- If you are loading prepunched paper for use with the staple finisher, then make sure the holes on the long edge of the paper are on the right side of the tray.

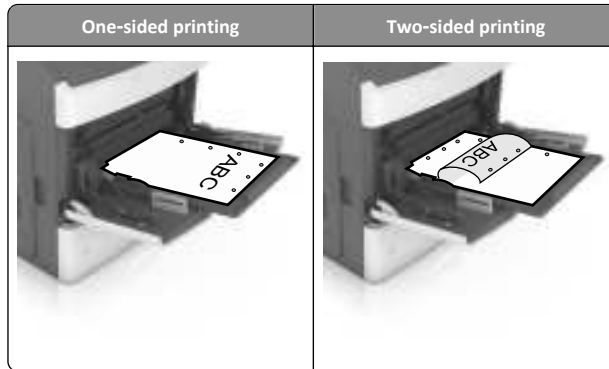

Note: If the holes on the long edge of the paper are on the left side of the tray, then a jam may occur.

- Load envelopes with the flap side down and on the left of the multipurpose feeder.



Warning—Potential Damage: Never use envelopes with stamps, clasps, snaps, windows, coated linings, or self-stick adhesives. These envelopes may severely damage the printer.

- Make sure the paper or specialty media is below the maximum paper fill indicator.

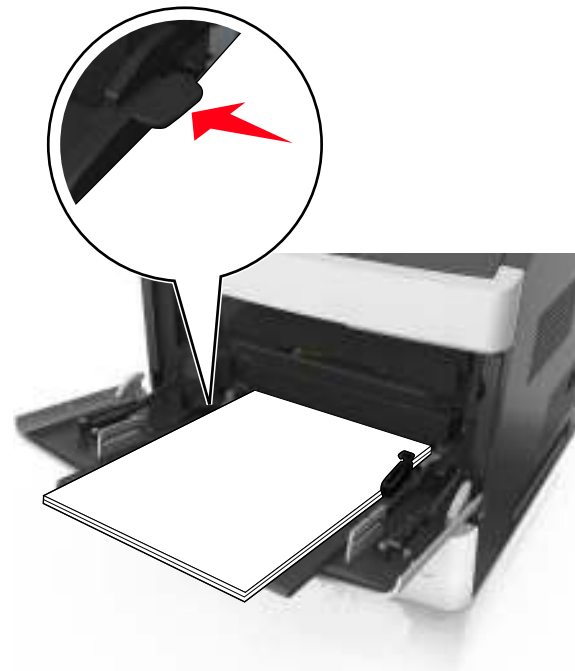

Warning—Potential Damage: Overfilling the feeder can cause paper jams.

- 6 For custom- or Universal-size paper, adjust the width guides to lightly touch the sides of the stack.
- 7 From the printer control panel, set the paper size and type in the Paper menu to match the paper loaded in the tray.

Note: Set the correct paper size and type to avoid paper jams and print quality problems.

Clearing jams

Carefully select paper and specialty media, and then load them properly to avoid paper jams. For more information, see “Avoiding jams” on page 20. If jams occur, then follow the steps outlined in this chapter.

Note: Jam recovery is set to Auto by default. The printer reprints jammed pages unless the memory required to hold the pages is needed for other printer tasks.

Avoiding jams

Load paper properly

- Make sure paper lies flat in the tray.

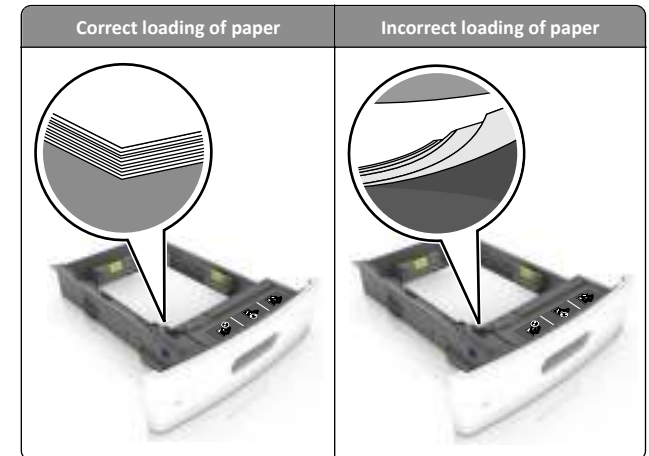

- Do not remove a tray while the printer is printing.
- Do not load a tray while the printer is printing. Load it before printing, or wait for a prompt to load it.
- Do not load too much paper. Make sure the stack height is below the maximum paper fill indicator.

- Do not slide the paper into the tray. Load paper as shown in the illustration.

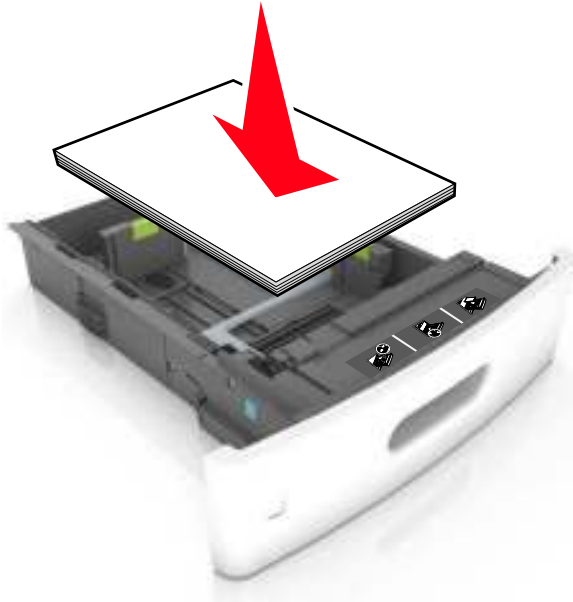

- Make sure the guides in the tray or the multipurpose feeder are properly positioned and are not pressing tightly against the paper or envelopes.
- Push the tray firmly into the printer after loading paper.
- If you are loading prepunched paper for use with the staple finisher, then make sure the holes on the long edge of the paper are on the right side of the tray. For more information, see the “Loading paper and specialty media” section of the *User's Guide*.

Allow the paper to enter the optional mailbox bins properly

- Make sure to adjust the bin extender so that the paper size indicators match the size of the paper used.

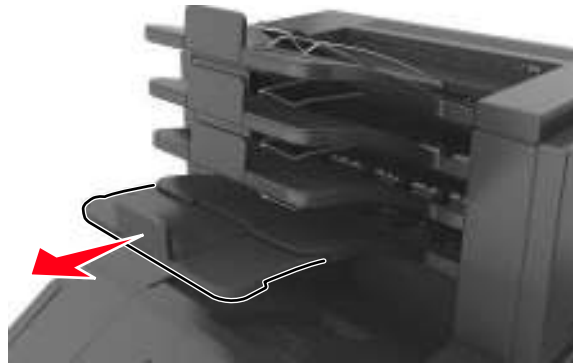

Notes:

- If the bin extender is shorter than the size of the paper you are printing on, then the paper causes a jam in the mailbox bin. For example, if you are printing on a legal-size paper and the bin extender is set to letter-size, then a jam occurs.
 - If the bin extender is longer than the size of the paper you are printing on, then the edges become uneven and the paper is not stacked properly. For example, if you are printing on a letter-size paper and the bin extender is set to legal-size, then the paper does not stack properly.
- If paper needs to be returned to the mailbox bin, then insert the paper under the bin arm, and then push the paper all the way back.

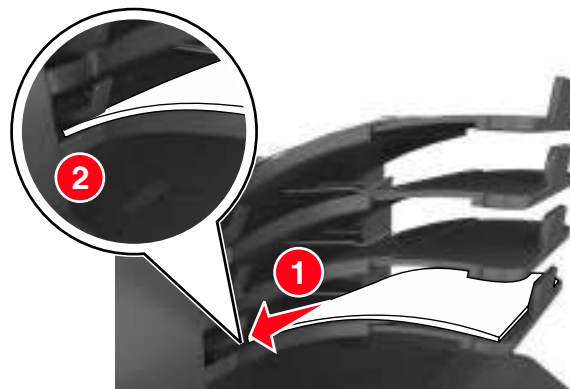

Note: If the paper is not under the bin arm, then a jam occurs due to an overfilled bin.

Use recommended paper

- Use only recommended paper or specialty media.
- Do not load wrinkled, creased, damp, bent, or curled paper.
- Flex, fan, and straighten paper or specialty media before loading it.

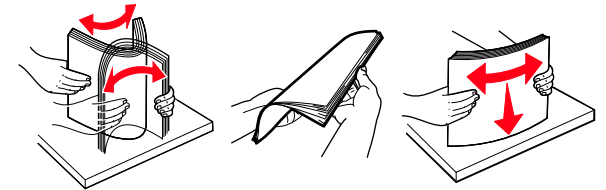

- Do not use paper that has been cut or trimmed by hand.
- Do not mix paper sizes, weights, or types in the same tray.
- Make sure the paper size and type are set correctly on the computer or printer control panel.
- Store paper per manufacturer recommendations.

Understanding jam messages and locations

When a jam occurs, a message indicating the jam location and information to clear the jam appears on the printer display. Open the doors, covers, and trays indicated on the display to remove the jam.

Notes:

- When Jam Assist is set to On, **Discarding pages** appears on the display and the printer flushes blank or pages with partial prints to the standard bin after a jammed page is cleared. Check your printed output for blank pages.
- When Jam Recovery is set to On or Auto, the printer reprints jammed pages. However, the Auto setting reprints jammed pages if adequate printer memory is available.

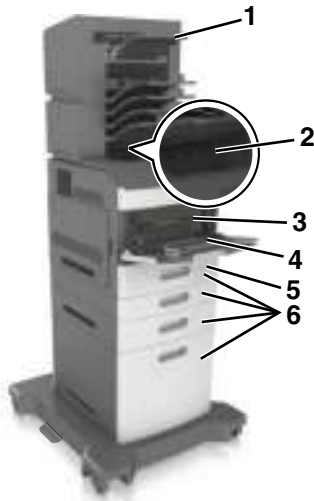

	Jam location	Printer message	What to do
1	Staple finisher	[x]-page jam, remove paper, open stapler door. Leave paper in bin. [455–457]	Remove paper from the stapler bin, open the stapler door, then remove the staple cartridge, and then remove the jammed staples.
2	Standard bin	[x]-page jam, remove standard bin jam. [203]	Remove jammed paper from the standard bin.

	Jam location	Printer message	What to do
3	Inside the printer	[x]-page jam, lift front cover to remove cartridge. [200–201]	Open the front cover and the multipurpose feeder, then remove the toner cartridge and the imaging unit, and then remove the jammed paper.
4	Multipurpose feeder	[x]-page jam, clear manual feeder. [250]	Remove all paper from the multipurpose feeder, and then remove the jammed paper.
5	Duplex area	[x]-page jam, remove tray 1 to clear duplex. [235–239]	Pull out tray 1 completely, then push down the front duplex flap, and then remove the jammed paper.
6	Trays	[x]-page jam, open tray [x]. [24x]	Pull out the indicated tray, and then remove the jammed paper.
7	Output expander	[x]-page jam, remove paper, open expander rear door. Leave paper in bin. [41y.xx]	Open the rear door of the output expander, and then remove the jammed paper.
8	Upper rear door	[x]-page jam, open upper rear door. [202]	Open the rear door of the printer, and then remove the jammed paper.
9	Upper door and rear duplex area	[x]-page jam, open upper and lower rear door. [231–234]	Open the rear door of the printer and the rear duplex area, and then remove the jammed paper.
10	Mailbox	[x]-page jam, remove paper, open mailbox rear door. Leave paper in bin. [43y.xx]	Open the rear door of the mailbox, and then remove the jammed paper.
11	Staple finisher rear door	[x]-page jam, remove paper, open finisher rear door. Leave paper in bin. [451]	Open the rear door of the staple finisher, and then remove the jammed paper.

[x]-page jam, lift front cover to remove cartridge. [200–201]

 **CAUTION—HOT SURFACE:** The inside of the printer might be hot. To reduce the risk of injury from a hot component, allow the surface to cool before touching.

- 1 Lift the front cover, and then pull down the multipurpose feeder door.

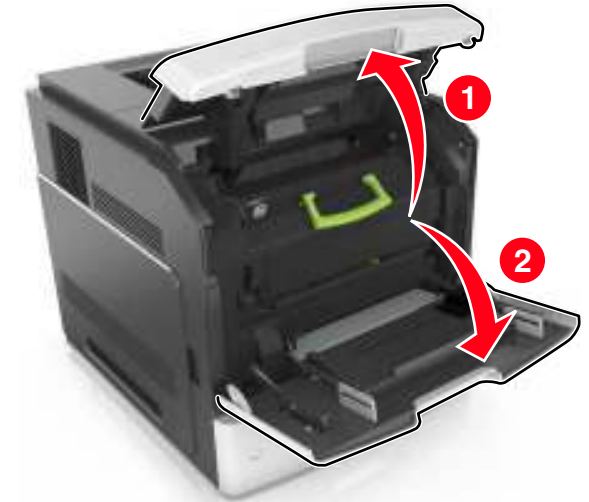

- 2 Lift the green handle, and then pull the toner cartridge out of the printer.

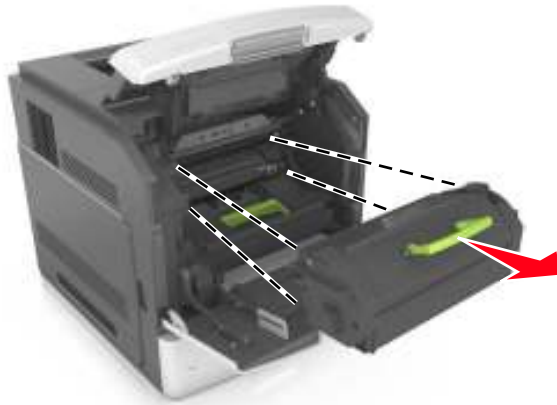

- 3 Place the cartridge aside.

- 4 Lift the green handle, and then pull the imaging unit out of the printer.

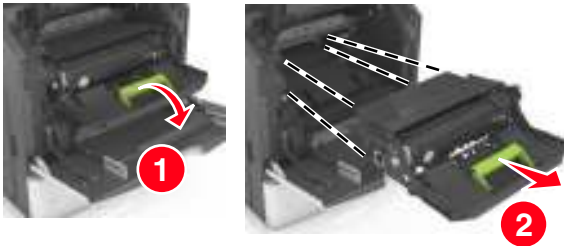

- 5 Place the imaging unit aside on a flat, smooth surface.

Warning—Potential Damage: Do not expose the imaging unit to direct light for more than 10 minutes. Extended exposure to light may cause print quality problems.

- 6 Pull the jammed paper gently to the right, and then remove it from the printer.

Note: Make sure all paper fragments are removed.

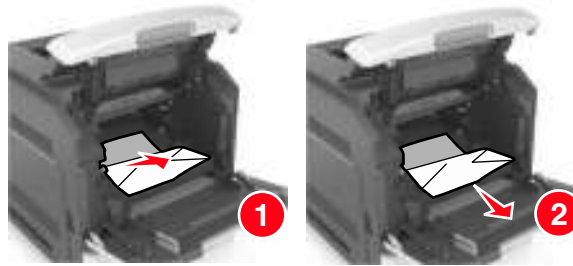

Warning—Potential Damage: The jammed paper may be covered with toner, which can stain garments and skin.

- 7 Install the imaging unit.

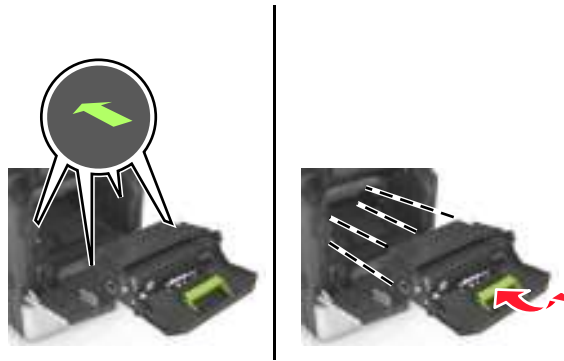

Note: Use the arrows on the side of the printer as a guide.

- 8 Insert the cartridge into the printer, and then push the green handle back into place.

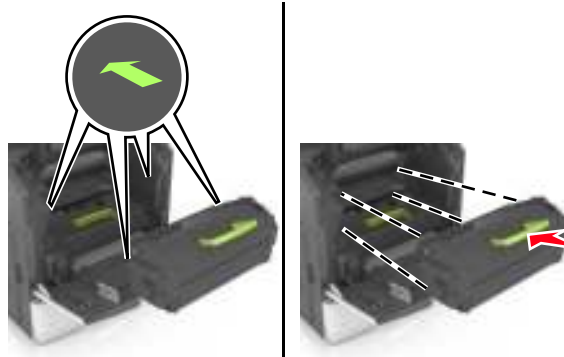



Notes:

- Align the arrows on the guides of the toner cartridge with the arrows in the printer.
- Make sure the cartridge is fully pushed in.

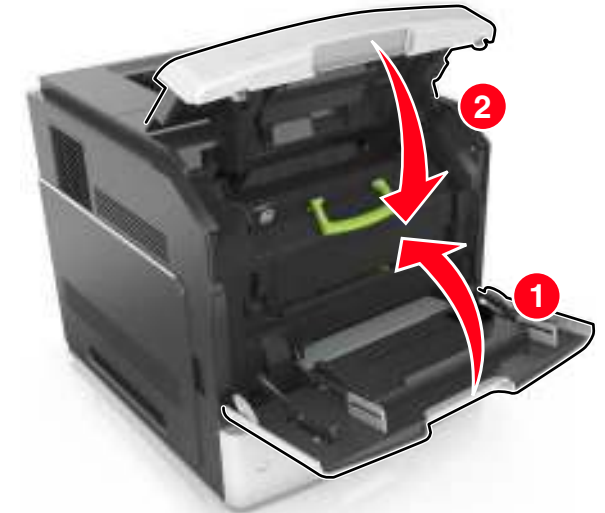
- 9 Close the multipurpose feeder door and the front cover.



- 10 Do either of the following to clear the message and continue printing:

- For touch-screen printer models, touch  or **Done**.
- For non-touch-screen printer models, select **Next** >  >
Clear the jam, press OK >  .

[x]-page jam, open upper rear door. [202]

 **CAUTION—HOT SURFACE:** The inside of the printer might be hot. To reduce the risk of injury from a hot component, allow the surface to cool before touching.

1 Pull down the rear door.



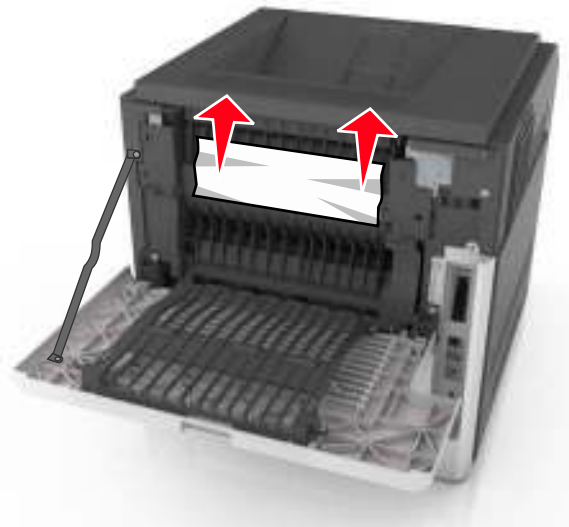

2 Firmly grasp the jammed paper on each side, and then gently pull it out.

Note: Make sure all paper fragments are removed.



3 Close the rear door.

4 Do either of the following to clear the message and continue printing:

- For touch-screen printer models, touch  or **Done**.
- For non-touch-screen printer models, select **Next** >  >
Clear the jam, press **OK** > .

[x]-page jam, open upper and lower rear door. [231–234]

 **CAUTION—HOT SURFACE:** The inside of the printer might be hot. To reduce the risk of injury from a hot component, allow the surface to cool before touching.

1 Pull down the rear door.



2 Firmly grasp the jammed paper on each side, and then gently pull it out.

Note: Make sure all paper fragments are removed.

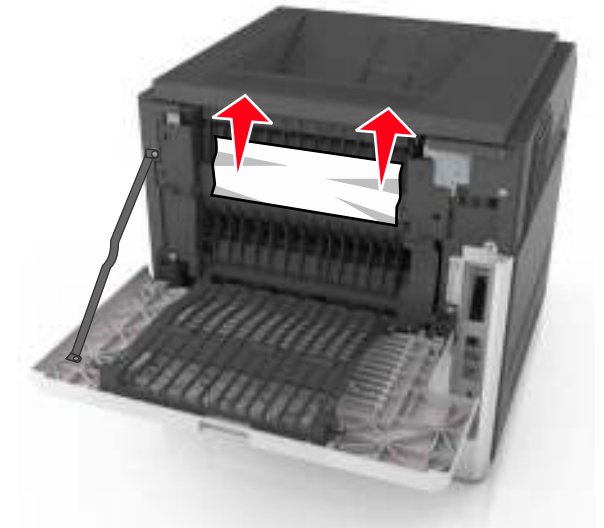

3 Close the rear door.

4 Push the back of the standard tray.



- 5 Press down the rear duplex flap, then firmly grasp the jammed paper, and then gently pull the paper out.

Note: Make sure all paper fragments are removed.

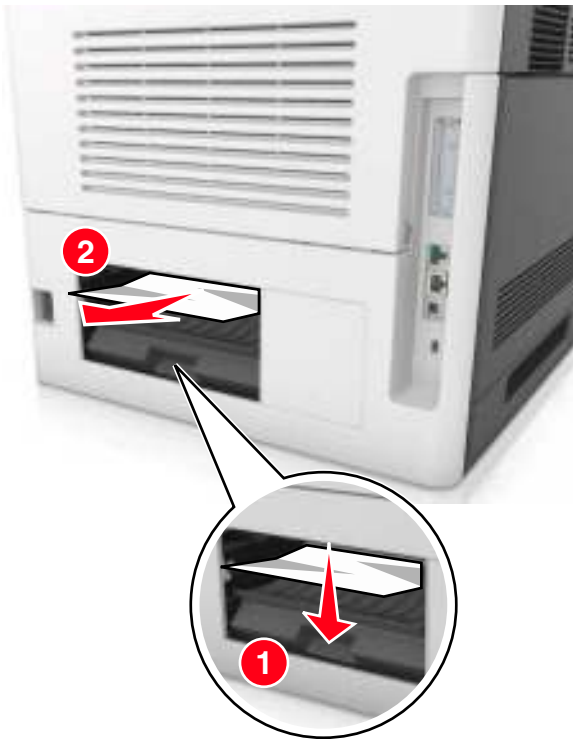

- 6 Insert the standard tray.

- 7 Do either of the following to clear the message and continue printing:

- For touch-screen printer models, touch or **Done**.
 - For non-touch-screen printer models, select **Next** > >
- Clear the jam, press OK > .

[x]-page jam, remove standard bin jam. [203]

- 1 Firmly grasp the jammed paper on each side, and then gently pull it out.

Note: Make sure all paper fragments are removed.

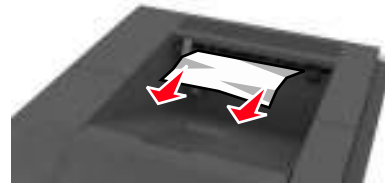

- 2 Do either of the following to clear the message and continue printing:

- For touch-screen printer models, touch or **Done**.
 - For non-touch-screen printer models, select **Next** > >
- Clear the jam, press OK > .

[x]-page jam, remove tray 1 to clear duplex. [235–239]

- 1 Pull out the tray completely.

Note: Lift the tray slightly and pull it out.

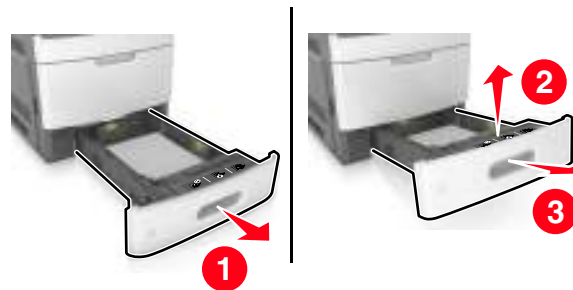

- 2 Push down the front duplex flap, then firmly grasp the jammed paper, and then gently pull the paper to the right and out of the printer.

Note: Make sure all paper fragments are removed.

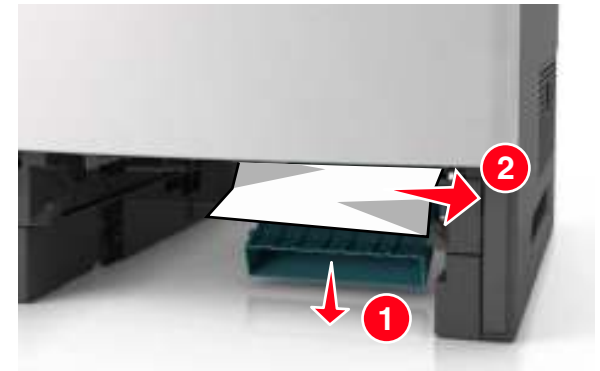

- 3 Insert the tray.

- 4 Do either of the following to clear the message and continue printing:

- For touch-screen printer models, touch or **Done**.
 - For non-touch-screen printer models, select **Next** > >
- Clear the jam, press OK > .

[x]-page jam, open tray [x]. [24x]

- 1 Check which tray is indicated on the printer display, and then pull the tray.



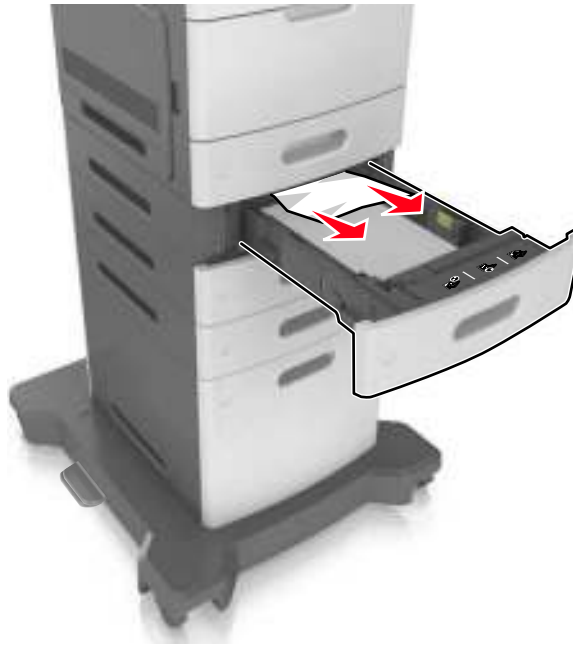

- 2 Firmly grasp the jammed paper on each side, and then gently pull it out.

Note: Make sure all paper fragments are removed.



- 3 Insert the tray.

- 4 Do either of the following to clear the message and continue printing:

- For touch-screen printer models, touch  or **Done**.
- For non-touch-screen printer models, select **Next** >  >
Clear the jam, press OK > .

[x]-page jam, clear manual feeder. [250]

- 1 From the multipurpose feeder, firmly grasp the jammed paper on each side, and then gently pull it out.

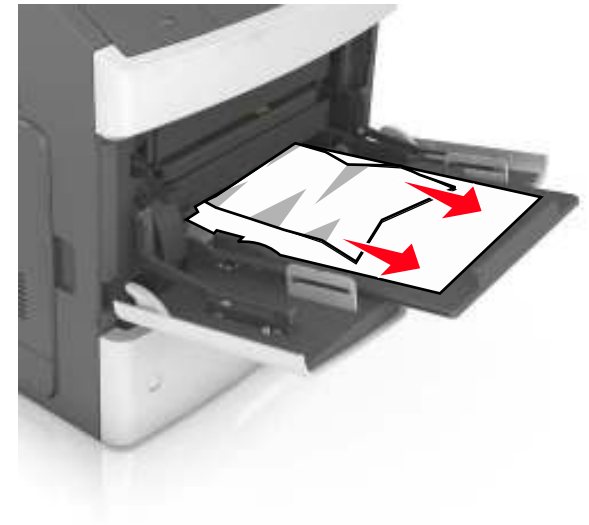

Note: Make sure all paper fragments are removed.

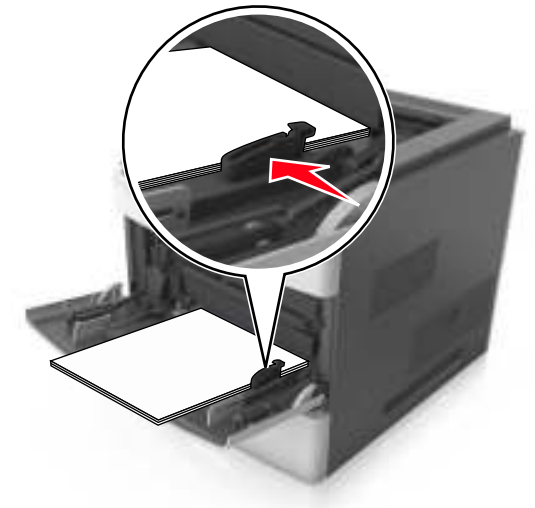

- 2 Flex the sheets of paper back and forth to loosen them. Do not fold or crease the paper. Straighten the edges on a level surface.
- 3 Reload paper into the multipurpose feeder.
- 4 Slide the paper guide until it lightly rests against the edge of the paper.



5 Do either of the following to clear the message and continue printing:

- For touch-screen printer models, touch  or **Done**.
- For non-touch-screen printer models, select **Next >**  **>**
Clear the jam, press **OK >** .

[x]-page jam, remove paper, open stapler door. Leave paper in bin. [455–457]

1 From the stapler bin, firmly grasp the jammed paper on each side, and then gently pull it out.

Note: Make sure all paper fragments are removed.

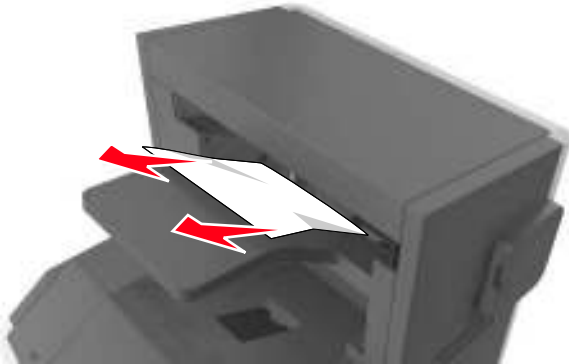

2 Open the stapler door.

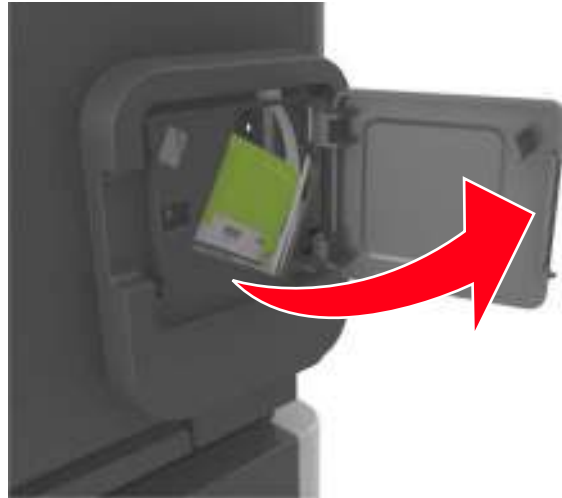

3 Pull down the latch of the staple cartridge holder, and then pull the holder out of the printer.



4 Use the metal tab to lift the staple guard, and then remove any loose staples.

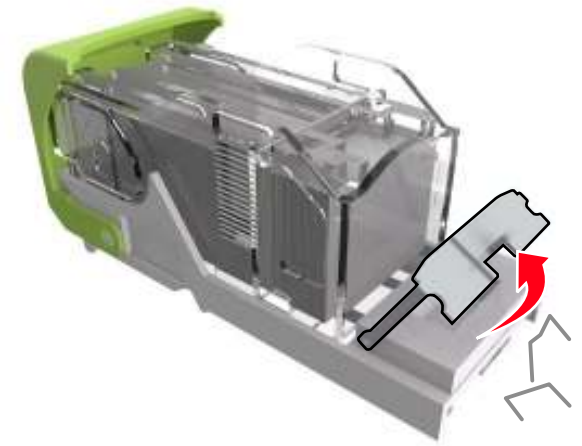

5 Press down the staple guard until it *clicks* into place.

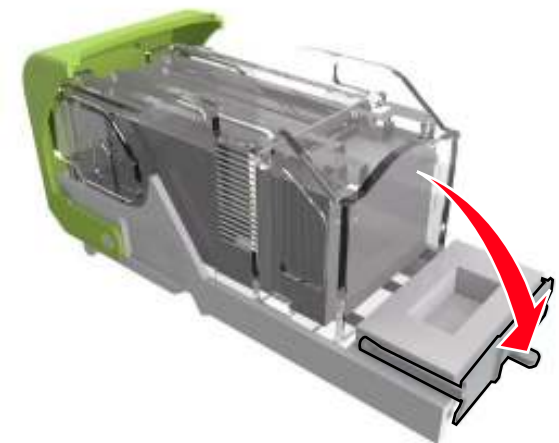

6 Press the staples against the metal bracket.





Note: If the staples are at the rear of the cartridge, then shake the cartridge downward to bring the staples near the metal bracket.



7 Push the cartridge holder firmly back into the stapler unit until the cartridge holder *clicks* into place.

8 Close the stapler door.

9 Do either of the following to clear the message and continue printing:

- For touch-screen printer models, touch  or **Done**.
- For non-touch-screen printer models, select **Next >**  **>**

Clear the jam, press OK >  **.**

[x]-page jam, remove paper, open finisher rear door. Leave paper in bin. [451]

1 Open the rear staple finisher door.





2 Firmly grasp the jammed paper on each side, and then gently pull it out.

Note: Make sure all paper fragments are removed.



3 Close the staple finisher door.

4 Do either of the following to clear the message and continue printing:

- For touch-screen printer models, touch  or **Done**.
- For non-touch-screen printer models, select **Next >**  >

Clear the jam, press **OK >** .

[x]-page jam, remove paper, open expander rear door. Leave paper in bin. [41y.xx]

1 Open the rear output expander door.



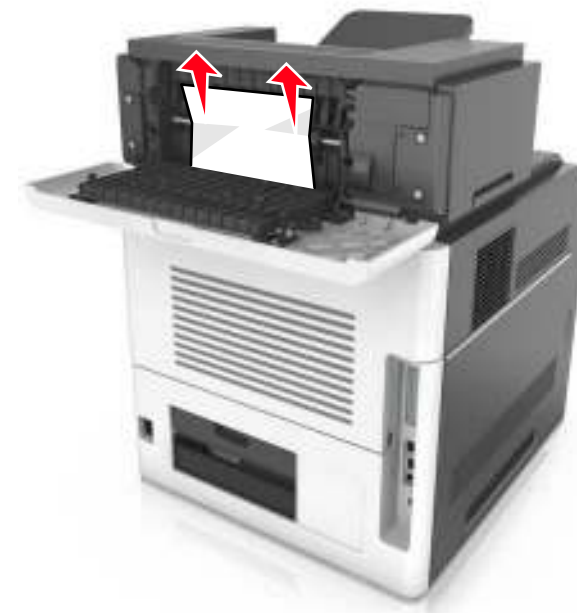

2 Firmly grasp the jammed paper on each side, and then gently pull it out.

Note: Make sure all paper fragments are removed.



3 Close the rear output expander door.

4 Do either of the following to clear the message and continue printing:

- For touch-screen printer models, touch  or **Done**.
- For non-touch-screen printer models, select **Next >**  >

Clear the jam, press **OK >** .

[x]-page jam, remove paper, open mailbox rear door. Leave paper in bin. [43y.xx]

1 Open the rear mailbox door.

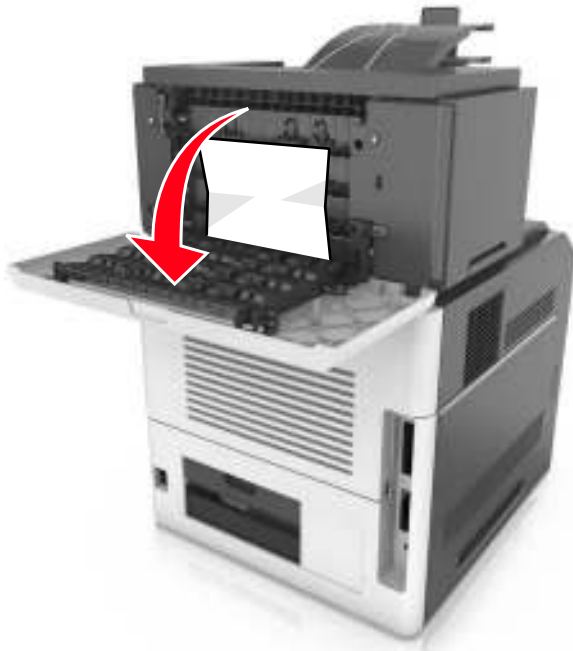

2 Firmly grasp the jammed paper on each side, and then gently pull it out.

Note: Make sure all paper fragments are removed.

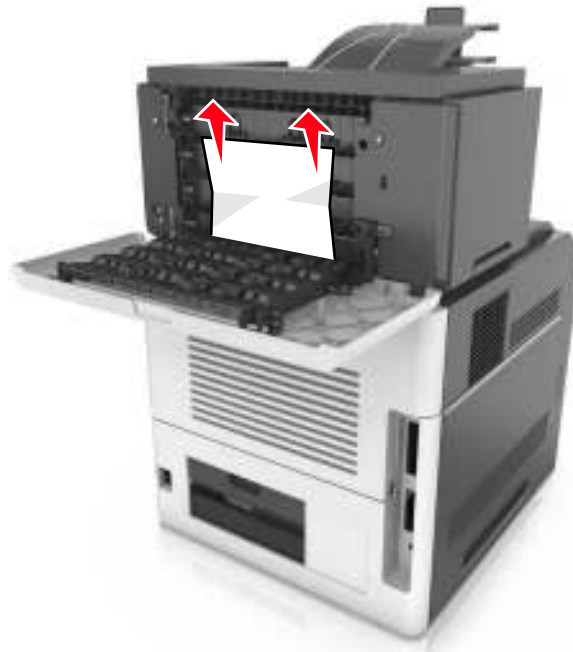

3 Close the rear mailbox door.

4 If the jam is in the mailbox bin, then firmly grasp the jammed paper, and then gently pull it out.

Note: Make sure all paper fragments are removed.

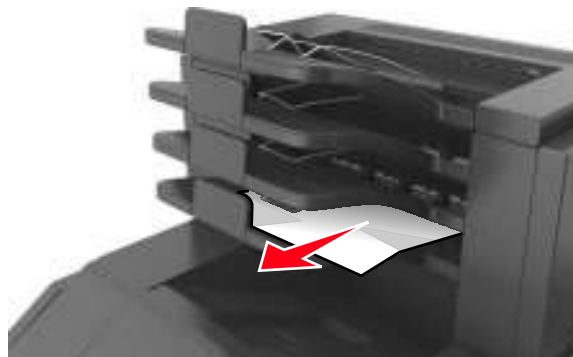

5 Do either of the following to clear the message and continue printing:

- For touch-screen printer models, touch  or **Done**.

- For non-touch-screen printer models, select **Next** >  >
Clear the jam, press OK > .