

Important: Warranty Disclaimer for Plans

For the convenience of our clientele, this website makes available conceptual plans that can be helpful in planning buildings, facilities, or other structures. They were developed over many years by engineers at Land Grant universities through the former USDA Cooperative Farm Buildings Plan Exchange. *Regardless of the original intent, these are older plans that provide conceptual information only, and are not to be considered or used as construction plans.*

These plans do not claim to represent the most current technology or the most recent construction techniques, standards, or codes. For example, over the years there have been changes in the National Design Specifications for Wood Construction, changes in the strengths and types of building materials, and changes in fasteners, among other things. Those changes, along with variations in climate, building codes, and other factors, make it imperative that professional services be utilized for your specific project. Suggested services include, but are not limited to, structural design, assurance of compliance with codes and regulations, site selection, construction supervision, and provision for utilities, waste management, and access. *These plans do not replace the need for competent design assistance in developing safe, legal, and well-functioning agricultural buildings and systems.*

Neither the University of Kentucky, the Midwest Plan Service, the United States Department of Agriculture, nor any of the cooperating Land Grant universities, warranty these plans. They are for conceptual use only and are not for use as construction plans.

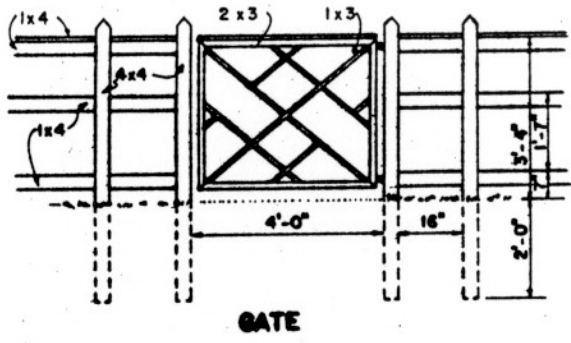

GATE

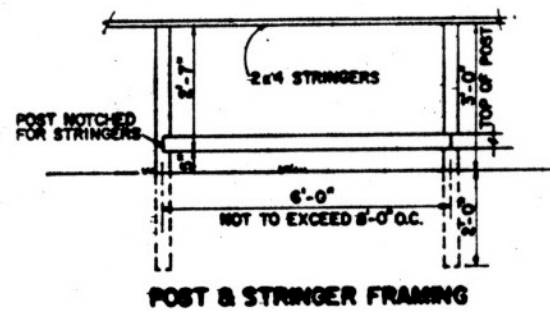

POST & STRINGER FRAMING

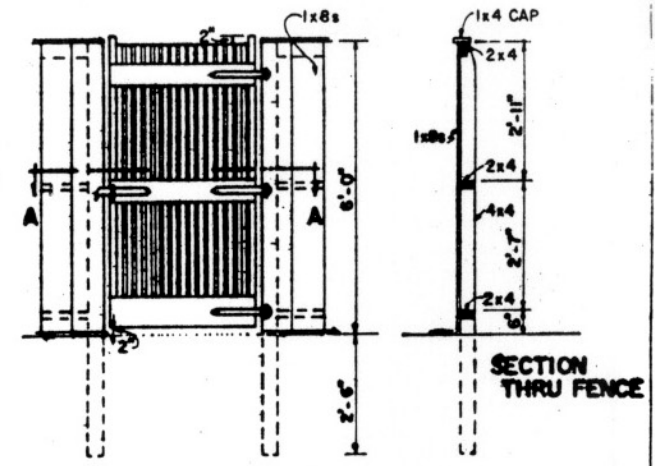

LOUVERED GATE

SECTION THRU FENCE

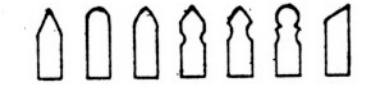

PATTERNS FOR PICKET TOPS

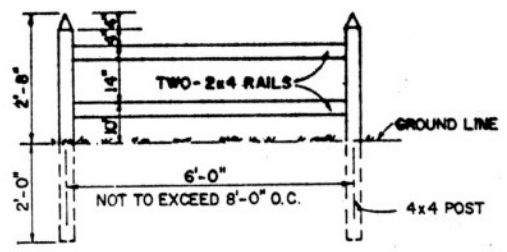

STRETCHER FENCE

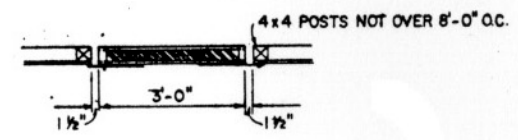

SECTION "A-A"

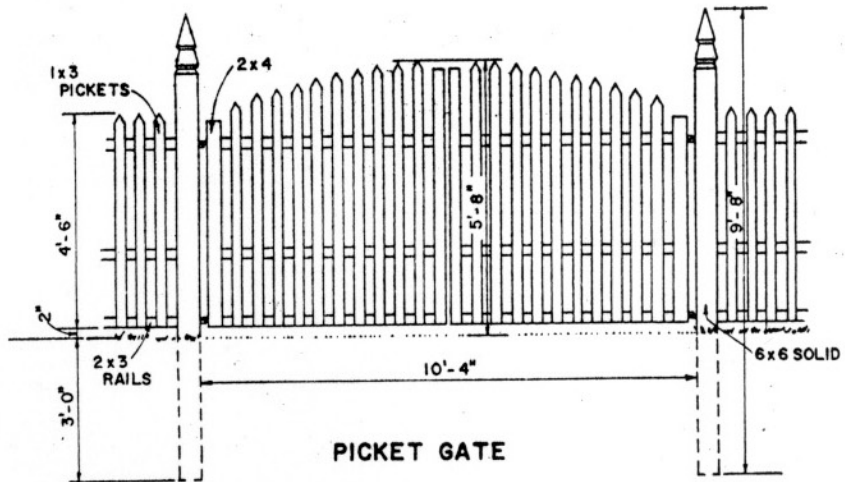

PICKET GATE

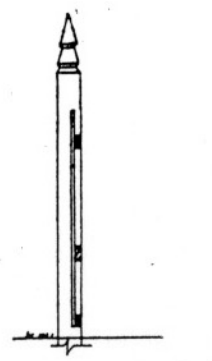

SECTION THRU FENCE

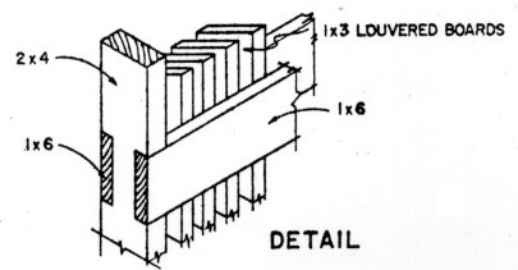

DETAIL

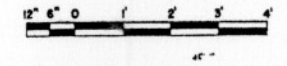

Agricultural Engineering Department
 Cooperative Extension Service
 University of Maryland
 College Park — Eastern Shore
 U.S. Dept. of Agriculture Cooperating

TYPES OF WOOD FENCING

USDA	'77	6286	SHEET 1 OF 2
------	-----	------	--------------

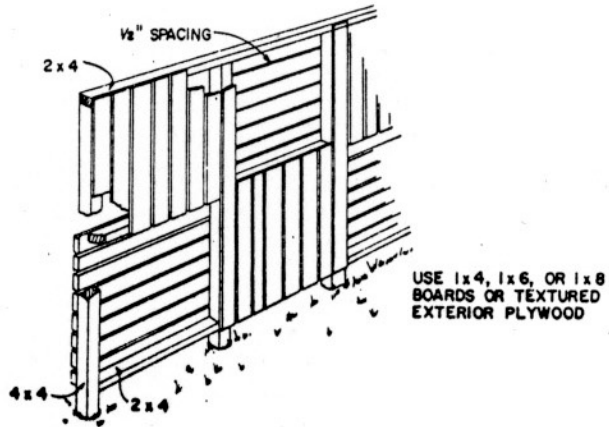

NOVELTY PATTERN

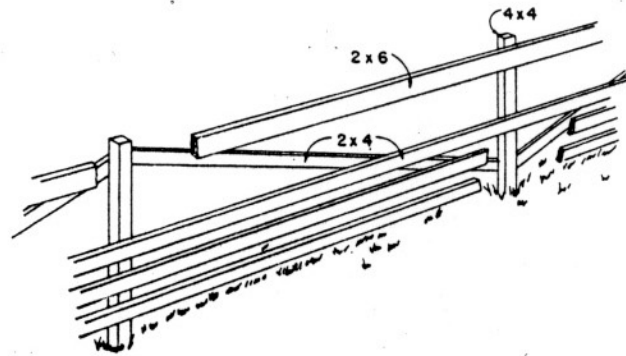

LOW RAIL FENCE

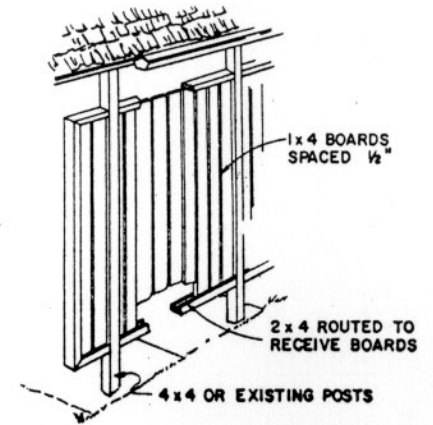

PRIVACY SCREEN

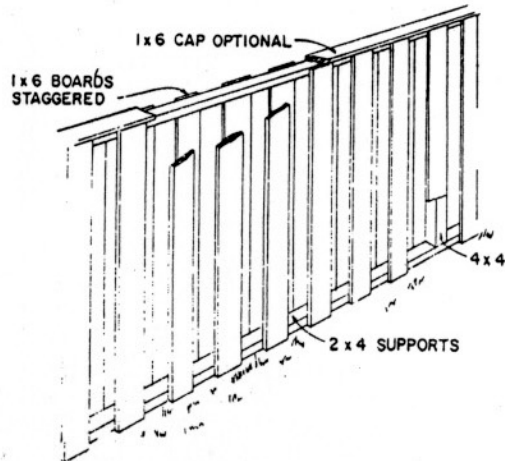

ALTERNATE BOARD FENCE

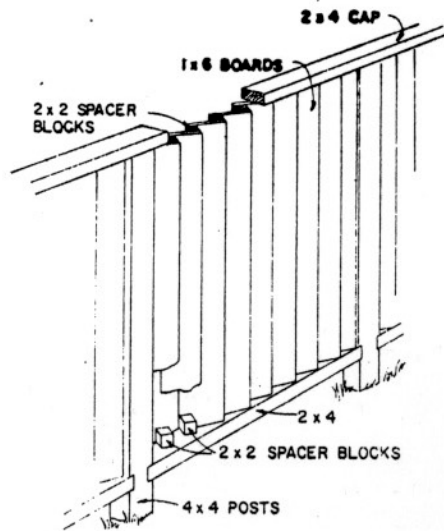

LOUVERED FENCE

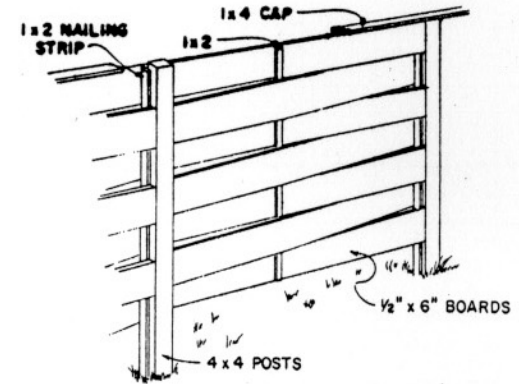

BASKET WEAVE FENCE

NO SCALE

Agricultural Engineering Department
 Cooperative Extension Service
 University of Maryland
 College Park — Eastern Shore
 U.S. Dept. of Agriculture Cooperating

TYPES OF WOOD FENCING

USDA '77 6286 SHEET 2 OF 2